

2.6

Infrastructure

The greatest challenge for any global city is the supply, funding and delivery of essential physical and social infrastructure. Doing this well creates and sustains a resilient city with high standards of living and contributes to its sustainable growth.

This sub-section describes key infrastructure issues in Central Sydney. How people move around metropolitan Sydney largely determines its success from an economic, environmental and social perspective. As such the sub-section has a substantial focus on transportation infrastructure, including current growth and changes and the need for better linkages between Central Sydney's open spaces.

It also discusses social infrastructure, including the need for affordable housing. Community facilities are crucial for residents as well as workers. Finally, the needs for energy infrastructure are described.

The sub-section does not address all of Central Sydney's infrastructure needs and it is intended that the Strategy will require the development of an infrastructure plan that goes beyond the infrastructure needs identified below, to address issues including waste, telecommunications, fibre optics, gas, sewerage, stormwater and water, education, health and State public transport.

Transportation

An integrated, safe and efficient transport network is critical to support growth in Central Sydney.

Central Sydney's current transport and access network is under considerable strain. Metropolitan Sydney's bus and rail networks are now heavily utilised, with little spare capacity on most rail lines, and severe congestion on the bus network. Central Sydney's streets have also reached capacity. Dominated by motor traffic, they rarely function as useable and inviting public spaces; they do little to enrich the human experience of Central Sydney at street level.

Planned public transport projects, including the Sydney metro and the expanded light rail network, will help ease Central Sydney and metropolitan Sydney's congestion challenges. But these are only part of the solution. There is still much to be done.

Demand

Central Sydney draws workers from across metropolitan Sydney, but the workforce is dominated by those from the inner and middle ring areas, particularly the Eastern and Northern Suburbs. Over the previous decade to 2011, the Inner West and Inner South West have contributed an increasing proportion of Central Sydney workers, reflecting population growth and demographic changes (refer to 2_43).

As metropolitan Sydney has grown, so too has the importance of public transport. Unlike travel in private vehicles, public transportation can move large crowds, taking up little space. Over the last 10 years, the number of people driving to Central Sydney in the morning peak hour reached a plateau of around 25,000 trips, while public transport use has increased from 105,000 to 145,000 trips.

Central Sydney generates intense demand for transportation. More than 180,000 people arrive each morning peak hour. The majority of trips, especially longer trips, are by train. Buses meet about 20 per cent of the morning's peak travel demand, and provide additional access to inner and middle ring suburbs that are not as well serviced by trains. Private vehicles account for only 14 per cent of the morning peak travel demand, though they account for most of the traffic on Central Sydney streets. The radial structure of metropolitan Sydney's transport network directs large volumes of passengers and vehicles through Central Sydney en route to other destinations. Approximately 67,000 journeys pass through Central Sydney, the majority of which are travelling to and from work in North Sydney, Chatswood and the Macquarie Park area. These through trips can place particular pressure on inbound rail services on the Western Line, which must cope with overlapping demand for Central Sydney and North Sydney destinations, leading to heavy loading between Central Station and Town Hall Station.

2_43

Origin of weekday (all day) trips to Central Sydney – 2011
Sydney City Centre Access Strategy 2013, NSW Government

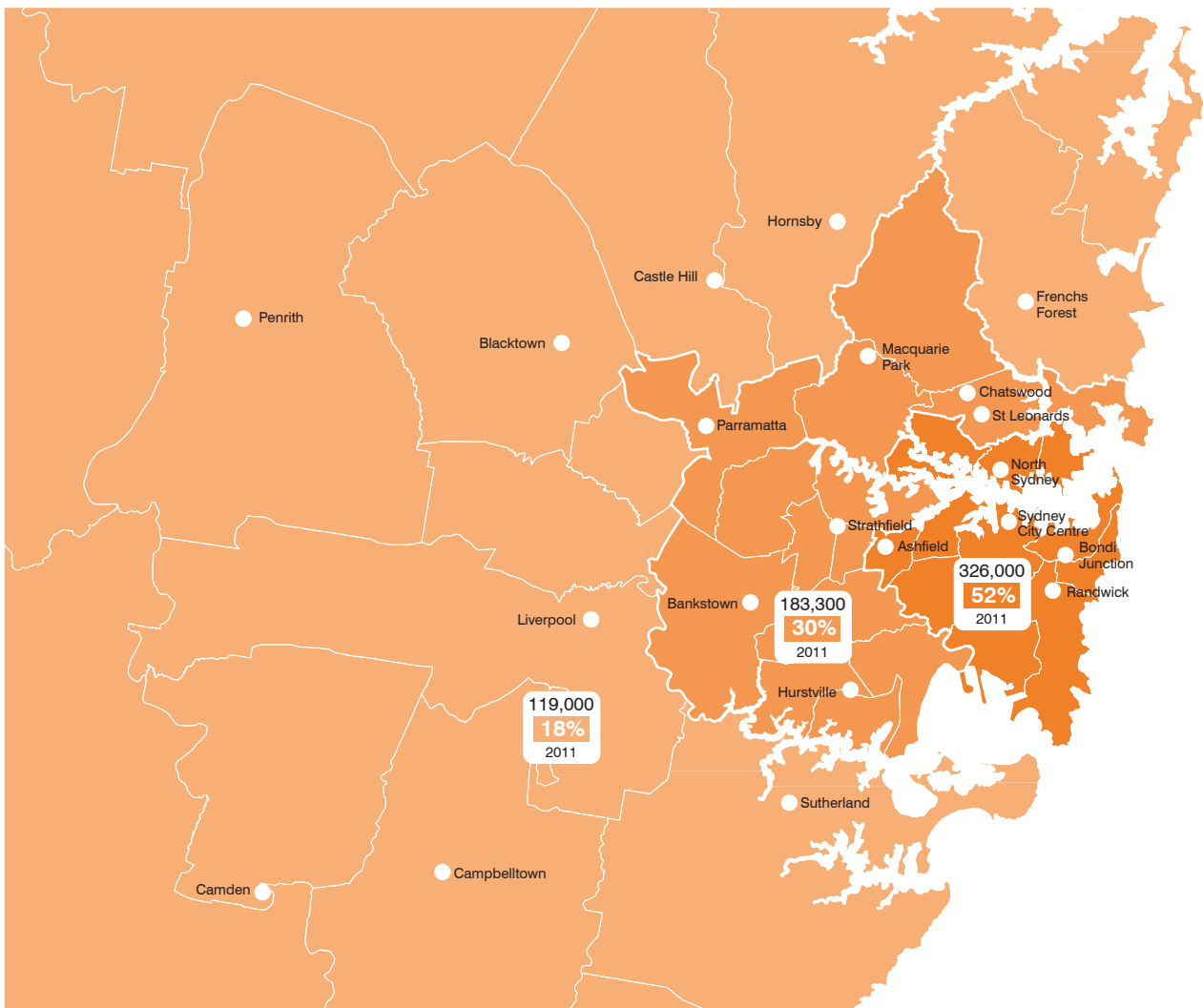

Public transportation

Fixed rail – heavy rail and metro rail – provides the capacity for transportation that underpins Central Sydney’s economy. Thus, the performance and growth of the rail network is inseparable from Central Sydney’s prosperity. But Central Sydney’s current level of public transport provision cannot comfortably accommodate a workforce of more than 340,000. On current trends, that level of employment will be reached by 2026, within the next ten years.

The introduction of CBD and South East Light Rail, the Sydney Metro, continued growth in active travel and a range of other transport initiatives such as the managed growth of bus, ferry and light rail corridors could accommodate another decade’s worth of employment growth, beyond 2036 (refer to 2_44).

The introduction of the CBD and South East Light Rail will change the way people travel to and move around the City of Sydney, creating a different pattern of how people use surface transport. The surface transport infrastructure provided to serve Green Square and Parramatta Road will also affect Central Sydney. Without investments in additional light rail and metro in areas that service Central Sydney with a workforce, Central Sydney would be required to accommodate a 30 per cent increase in bus numbers beyond 2030, creating significant degradation in performance and amenity, and further pressure on roads.

More study is needed to prepare for these changes, with issues to be examined including: how to improve interchange between modes of transport; bus rerouting to ease congestion and expand cross-regional connections, and reduction in the high-value space allocated to bus-only parking spaces.

Outside Central Sydney, these changes will be complemented by new rail and metro stations that relieve overburdened radial bus routes, reducing the total volume of buses in Central Sydney streets. Another way to accommodate change is to combine transport stops and public open space, particularly at Central Sydney’s planned three major squares.

Supporting employment growth beyond 2036 will require transformation in providing access to Central Sydney, such as the construction of the next stage of the Sydney Metro rail

network. Delivering public transport is the responsibility of the State Government. It is critical that the State now starts quantifying demand and identifying solutions beyond the 2036 date set in Sydney’s Rail Future (June 2012) the NSW Government’s plan to modernise metropolitan Sydney’s rail network. The plan currently outlines the Sydney Metro, Australia’s largest public transport project. It comprises two key components:

- Sydney Metro Northwest, formerly the 36-kilometre North West Rail Link – This project is now under construction and will open in the first half of 2019 with a metro train every four minutes at peak hours.
- Sydney Metro City and Southwest – A new 30-kilometre metro line linking with Metro Northwest at Chatswood, and then under Sydney Harbour, through the CBD and southwest to Bankstown. It is due to open in 2024 with the capacity to run a metro train every two minutes each way under the centre of Sydney.

Stations in Central Sydney are planned at Central, Pitt Street and Martin Place with recent agreement for another station at Barangaroo. This will take considerable pressure off Wynyard Station and reduce the intensity of pedestrian traffic between Wynyard and Barangaroo.

The CBD and South East Light Rail projects are currently under construction and due to open in 2019. The 12-kilometre light rail route will travel from Circular Quay along George Street to Central Station and on to Moore Park, then to Kingsford via Anzac Parade and Randwick via Alison Road and High Street.

This major infrastructure project is being delivered by the NSW Government with the City of Sydney contributing \$220 million, including funding the transformation of George Street and the improvement of surrounding laneways.

However, as the metropolitan centre extends beyond Central Sydney to nearby areas like the Bays and Central to Eveleigh, additional fast, reliable public transport connections are needed to maximise the productivity of an expanded metropolitan centre.

2_44

Workforce population and transport capacity

Source: SGS economics and planning and City of Sydney, 2015

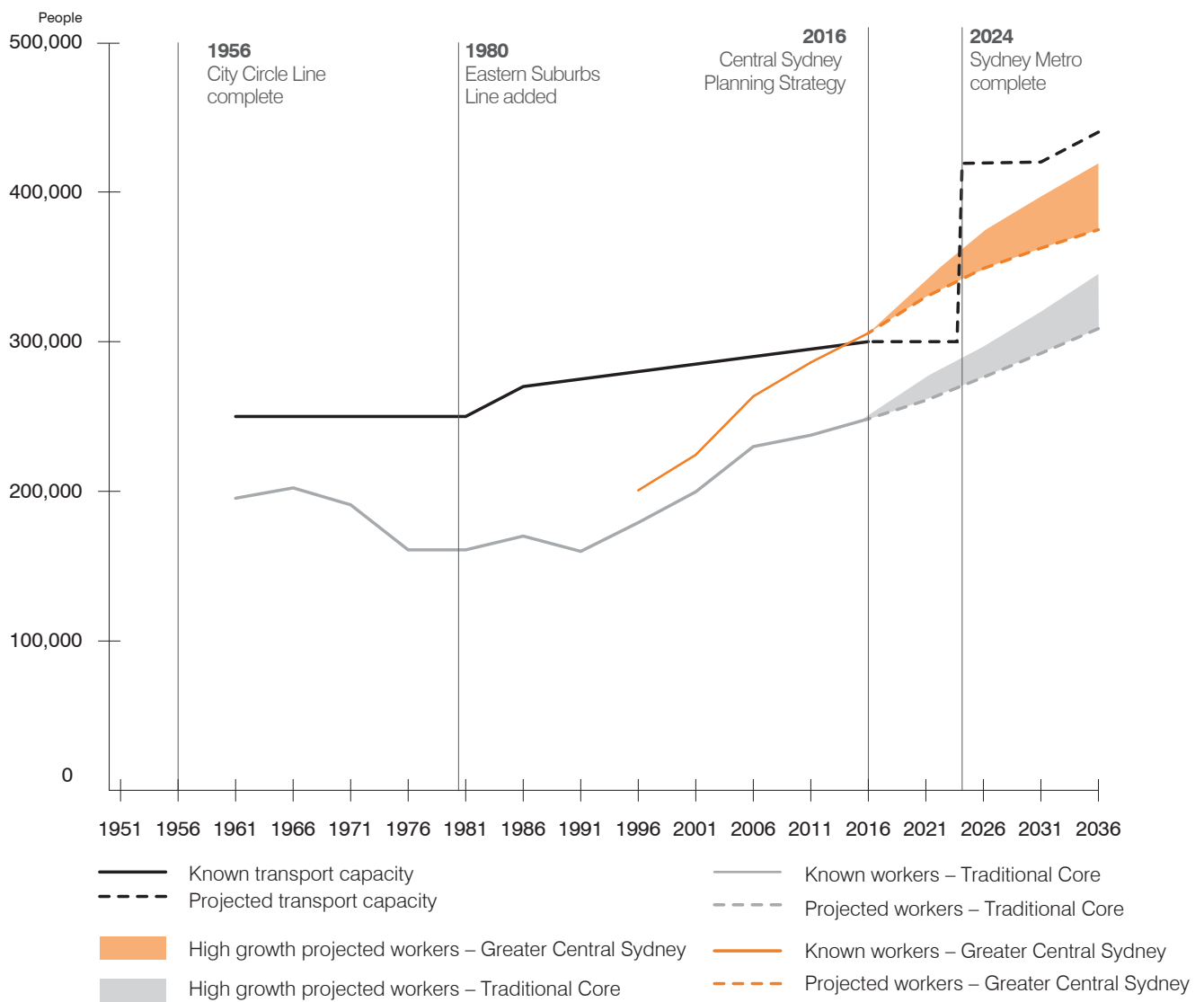

Proposed heavy rail

Existing heavy rail line and station

Proposed metro line

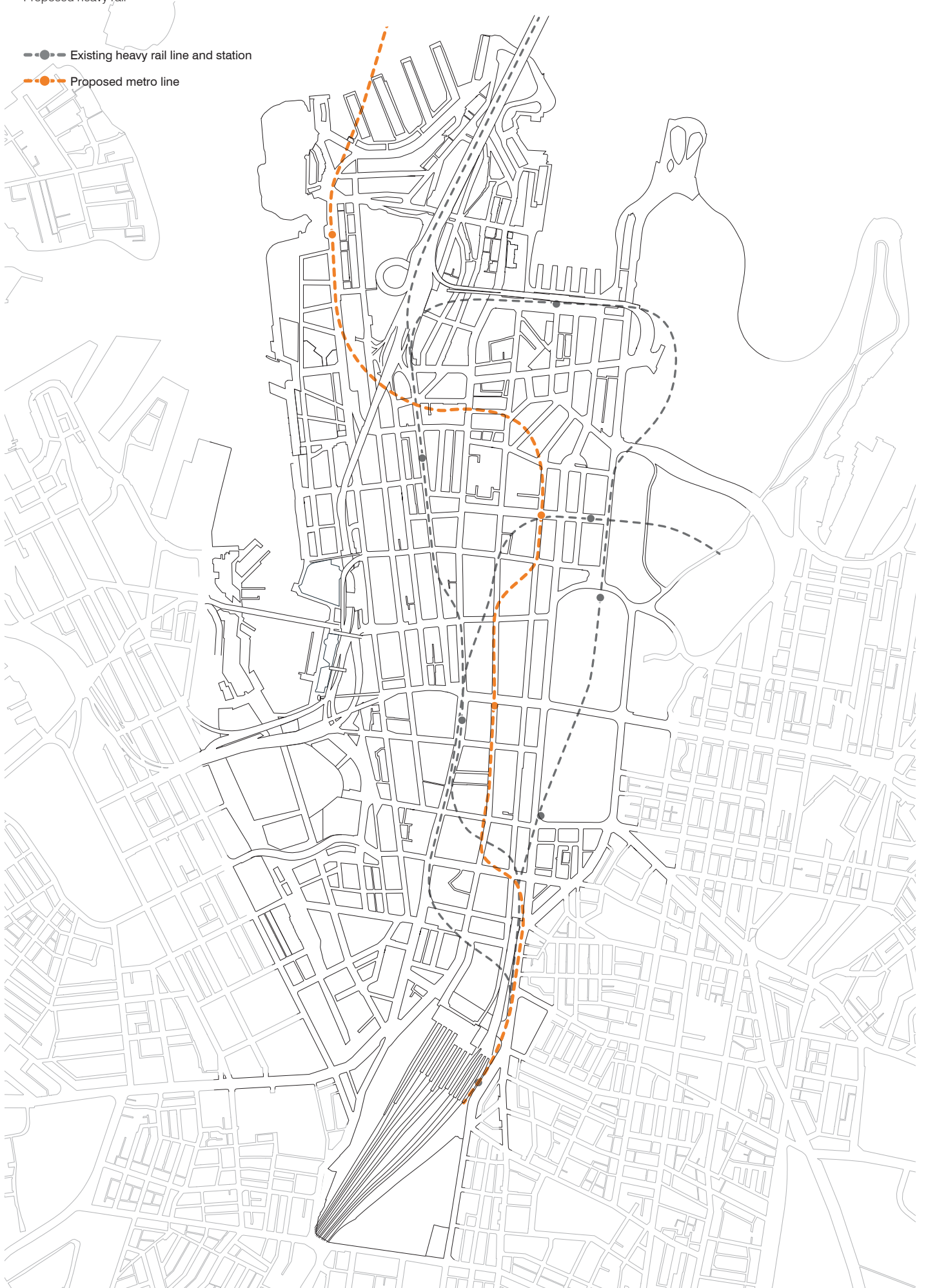

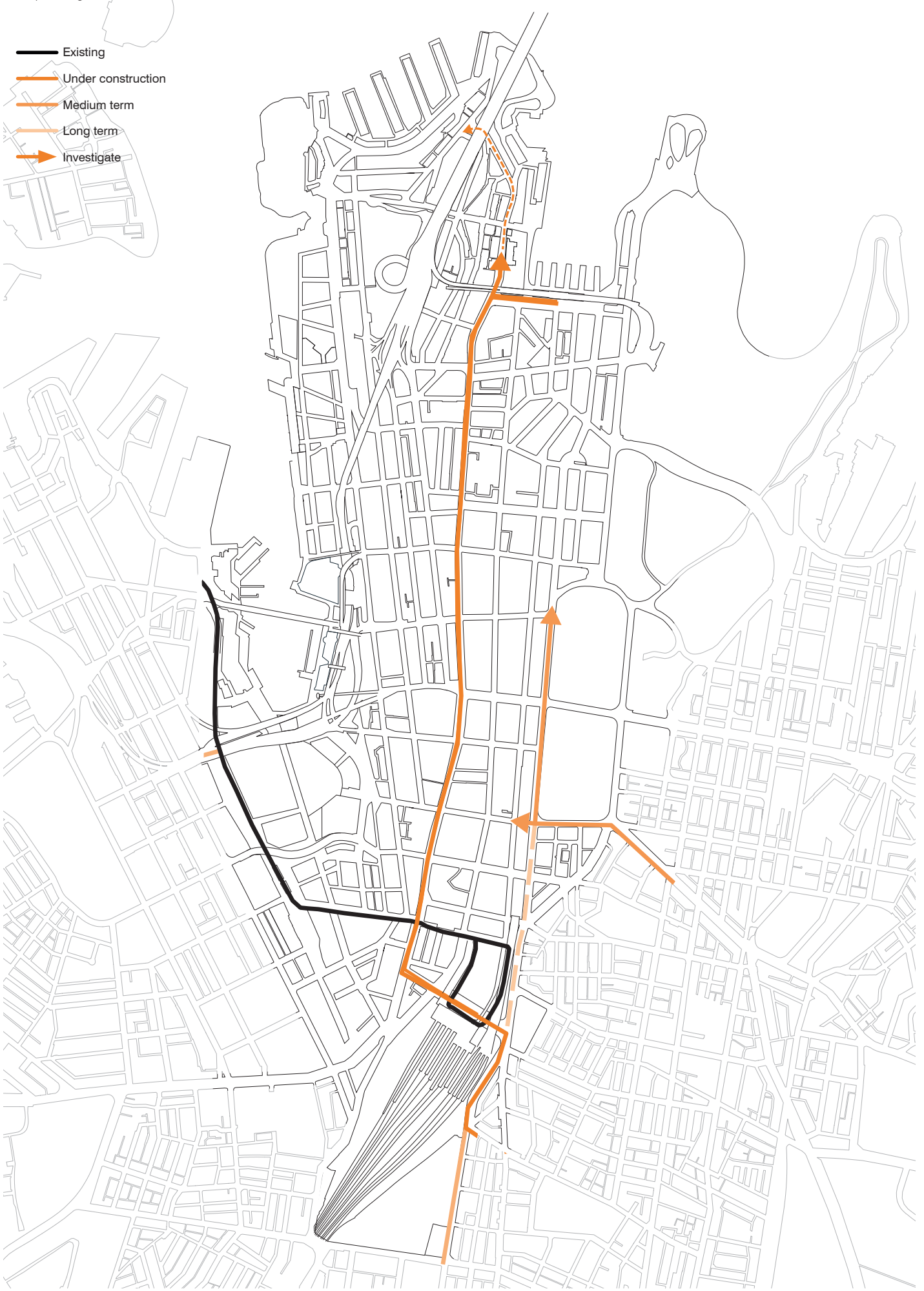

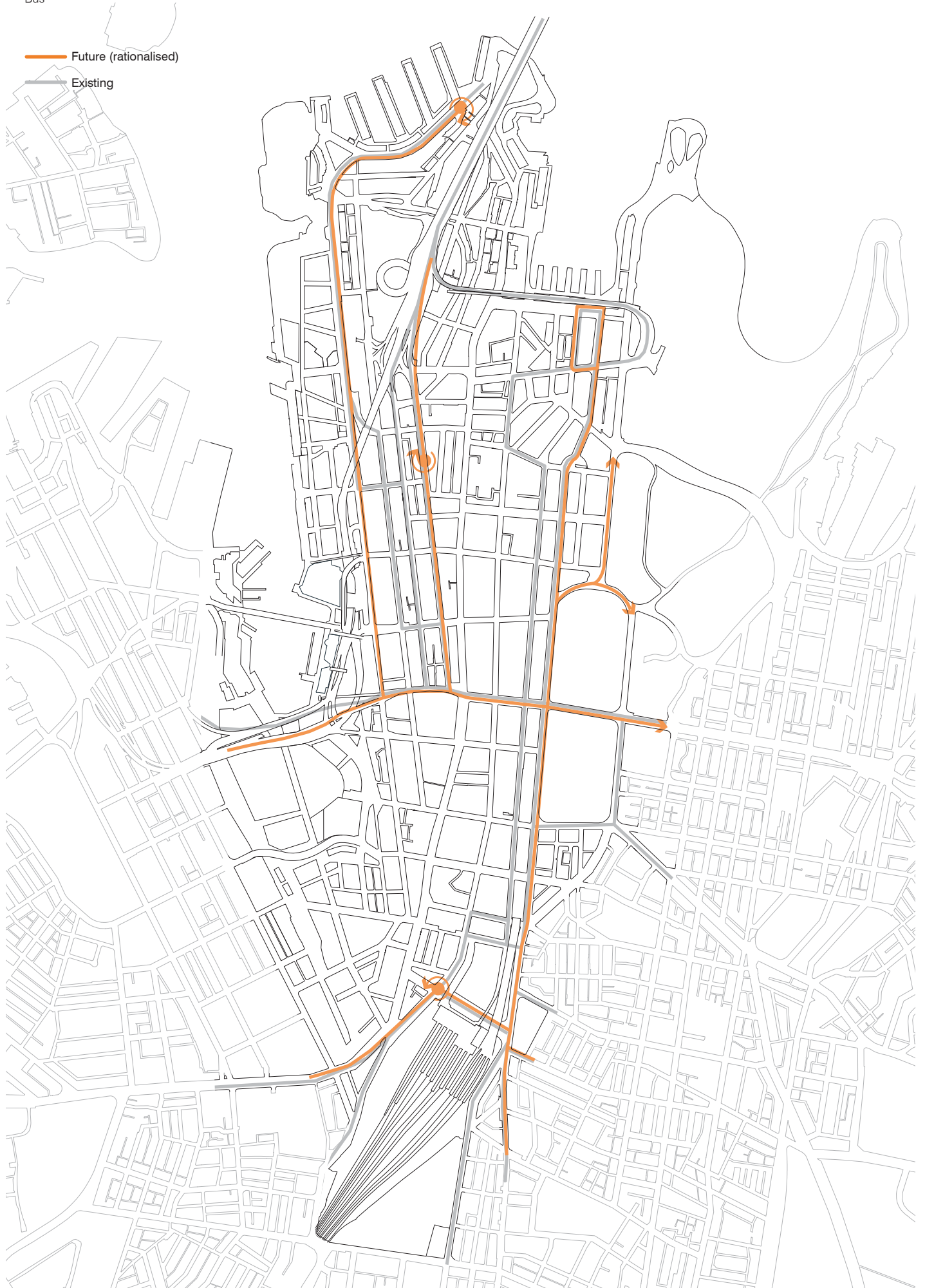

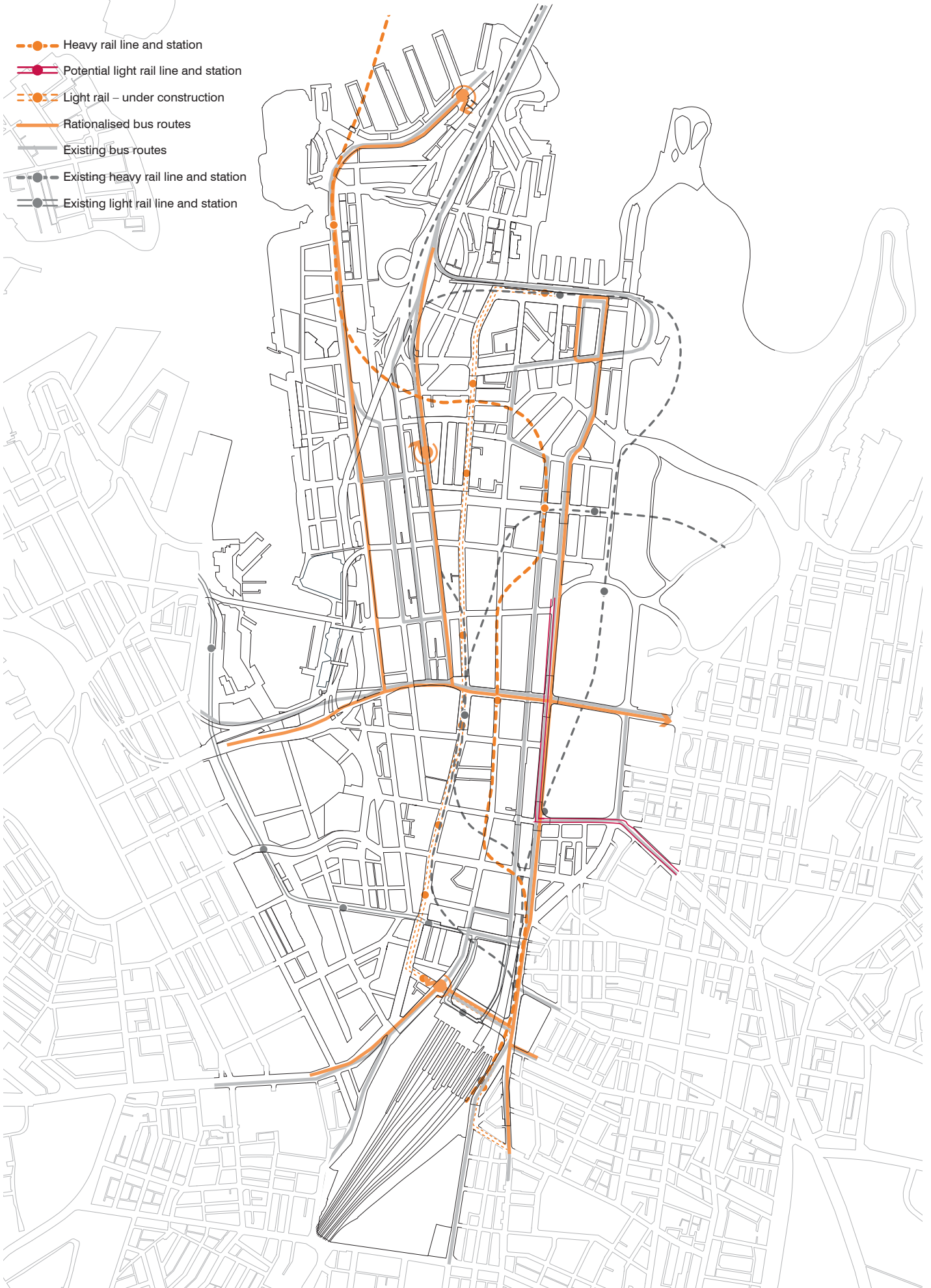

Walking

Walking has nearly doubled in the last 10 years as a mode of transport. This largely reflects that more people live in Inner Sydney suburbs such as Pyrmont, Haymarket and Chippendale. In 2011, residents of the City of Sydney made 46 per cent of Central Sydney-bound work trips by walking.

Within Central Sydney, walking accounts for 90 per cent of all internal trips. Walkability is reflected in the specialised professional and industry clusters that have formed around key destinations, from retailing at Pitt Street to legal services at Phillip Street, and financial services around Martin Place. The proportion of trips on foot is increasing – both for people walking their entire trip, and for those walking to or from public transport.

Studies indicate that truly walkable centres provide essential environments for the informal connections of business and private life. Public spaces like squares and semi-public spaces such as cafes, all accessed by walking, are becoming the places where connections are made, contracts are negotiated and deals are done. This trend requires greater attention to the needs of pedestrians and how to promote their productivity.

Demand for more pedestrian space will need to be satisfied within the finite area of streets. It will be increasingly difficult to allocate space among competing transport modes. To inform better decisions about allocating street space, better monitoring and data is required. Pedestrians, like cars, should be counted.

As pedestrian numbers in Central Sydney grow, the need for safer and more generous pedestrian spaces will increase. It is conceivable that many of Central Sydney's main streets could reach pedestrian capacity in the medium term. Understanding the current and future demand for pedestrian space in Central Sydney will be critical so the City can plan for increased pedestrian flows. Working with landowners will be needed to ensure new development makes a positive contribution to the street network.

Allocation of space to road traffic may need to be reconsidered and land owners and developers will need to work with the City of Sydney to provide for growth in the pedestrian network including through site links. Providing increased options for pedestrian's movements supports a more equitable Central Sydney where the pedestrian network is easily navigated and intuitive, promoting a highly productive, efficient and healthy Central Sydney.

The relationship between increased public transport provision and the need to increase capacity for pedestrians is often underappreciated. New metro and light rail infrastructure will increase activity and employment in Central Sydney, bringing in turn higher pedestrian numbers. As some bus corridors are replaced by rail and light rail, pedestrian activity will be increasingly concentrated at a small number of stops and stations. As more people enter Central Sydney, the increased demand for walking space on the street, particularly around and between key public transport access points, will need to be addressed.

Proposed pedestrian movement



Cycling

Since 2003, the number of bike riders has grown by more than 10 per cent per annum on major routes to the City, with peak cycling trips to Central Sydney likely to triple, and total cycling trips across the City likely to increase at least five times by 2036. This rapid rate of growth in the number of people choosing to cycle to and around the Central Sydney will be supported by completing the city centre cycleway network. This means some existing cycleways will be extended and additional ones built to connect the whole of the City of Sydney. In most cases, cycleways will be provided in street space currently not used for traffic movement, providing safer and more direct access for cyclists and encouraging them to use dedicated routes.

Social research undertaken by the City has indicated that the greatest barriers to cycling within the City are lack of safe, off-road bicycle lanes or paths. Prospective cyclists are daunted by the potential for riding a bicycle near parked cars or moving traffic. This also links strongly to the lack of proper cycle lanes, a linked network, dedicated cycle lights, markings on roads where cyclists are crossing or any of the other means that cities use to look after their citizens when they cycle.

Separating cycleways from vehicles, buses and pedestrians will provide safer and more direct access for cyclists and encourage them to use dedicated routes. This will reduce the conflicts between cyclists and other street users.

2_50

Proposed cycling routes
NSW State Government

- Strategic routes
- Routes to be determined
- Routes identified for removal

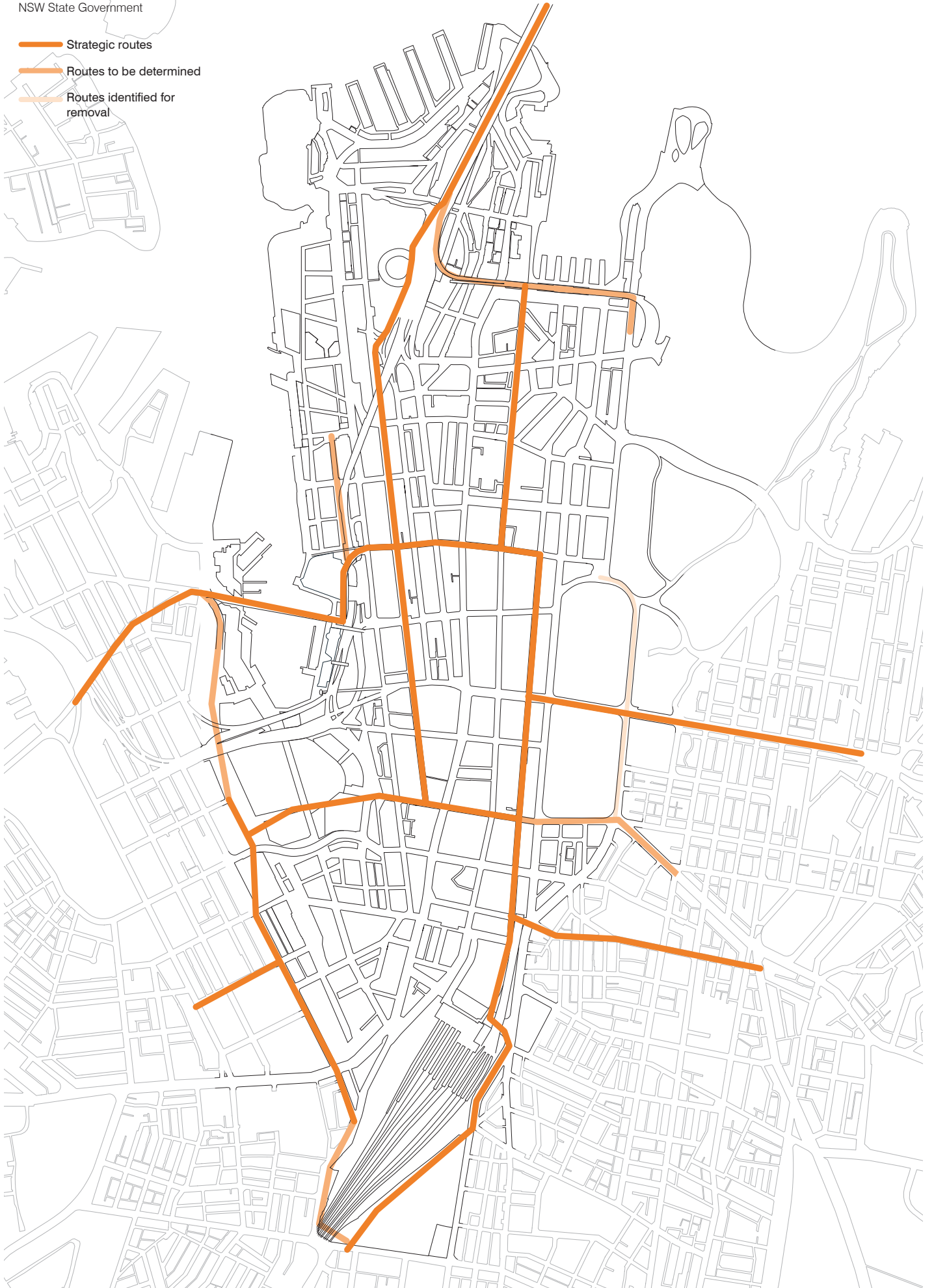

Vehicles

Traffic that goes through Central Sydney undermines the safety of other users of streets, which are assisted by very low traffic speeds. Through traffic encourages speeding, which serves no one but these drivers. It uses valuable and finite space required for other more productive purposes. Removing through traffic would improve the productivity and character of Central Sydney.

Private motor vehicles require more space to move less people than any other transport mode in Central Sydney. Their spatial inefficiency undermines the ability to promote the efficiency, comfort and safety of other modes.

Taxis and other for-hire vehicles provide transportation within, to and from Central Sydney for destinations not well served by public transport, for those who need to travel outside busy hours of public transportation hours, and for those who find other modes difficult.

While walking and public transport accommodate most internal and inbound journeys, the majority of space on Central Sydney streets is disproportionately taken by private vehicles. On George Street at Bathurst Street, for example, cars accommodate about 17 per cent of travellers, but occupy 40 per cent of the street.

Paradoxically, the majority of private vehicles used for commuting trips to Central Sydney originate in the Inner Suburbs where public transport is most available. Middle and outer suburban commuters to Central Sydney rarely drive, and rely heavily on the rail network. Only 13 per cent of Central Sydney-bound commuters from Liverpool and Fairfield travelled by private vehicle, while 25 per cent of Waverley and 28 per cent of Woollahra commuters to Central Sydney did so. This suggests that the quality of public transport coverage does not adequately explain the decision to drive to Central Sydney, which is more likely to be influenced by the availability of on-site parking.

2_51

Proposed car movement through Central Sydney

- Vehicle bypass loop
- Minor car movement path
- Junction



Central Sydney now has approximately 50,000 off-street parking spaces, divided between resident parking, tenant parking and publicly accessible parking stations. While most spaces are underground, they have a profound impact on the Central Sydney's limited street space. Because they accommodate so many cars, the traffic that results has a dominant impact on the management and character of Central Sydney's streets.

As Central Sydney and its surrounds grow, the pressures increase of managing street space. Careful attention to the supply and location of parking and loading docks can benefit all users with more space for pedestrians, more generous footpaths and public squares, reduced delays at intersections, and more efficient surface public transport. For private and delivery vehicles, it will mean reduced congestion, less pressure on kerbside loading and more efficient logistics.

The location of site entries and driveways can have profound impacts on the functioning and character of Central Sydney. Inappropriate driveway locations can detract from high value retail and commercial frontages, attract private traffic onto routes needed by existing or future public transport services, and exacerbate conflicts between pedestrians and cars. Driveways also further impede the capacity of footpaths to accommodate a growing worker and resident population.

While planners in 1971 had sought to direct parking to the Central Sydney's Western Edge, the need has been increasingly recognised to constrain supply. Parking encourages peak-hour traffic, exacerbating congestion on Central Sydney streets and regional feeder roads, delaying buses, and increasing costs for essential service vehicles. At street level, the accommodation of driveways and extra traffic limits footpath space for pedestrians, exacerbates noise and road danger, and results in long waits for pedestrians at crossings.

Meanwhile, the high-density land uses in Central Sydney generate significant demand for delivery and service vehicles, and their loading and servicing. Growth in online purchasing and changes in logistics supply chains have increased the proportion and frequency of small parcel delivery, with commensurate increases in light commercial vehicle traffic. All of this growth will require careful management to limit impacts on the traffic network, reduce demand on kerbside loading space and allow the efficient operation of surface public transport.

2_52

Night-time loading zones

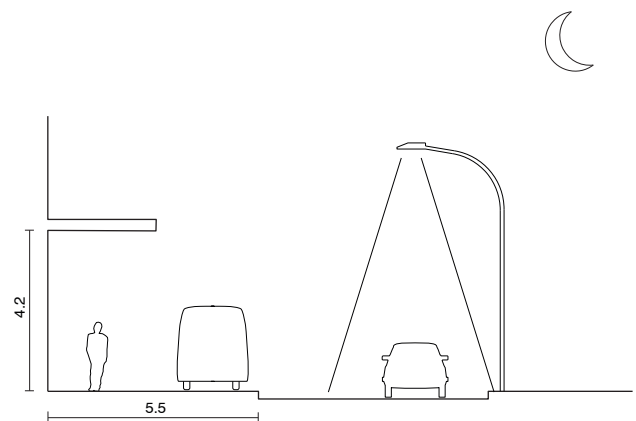

2_53

Public car parking (above and below ground)

Density of spaces

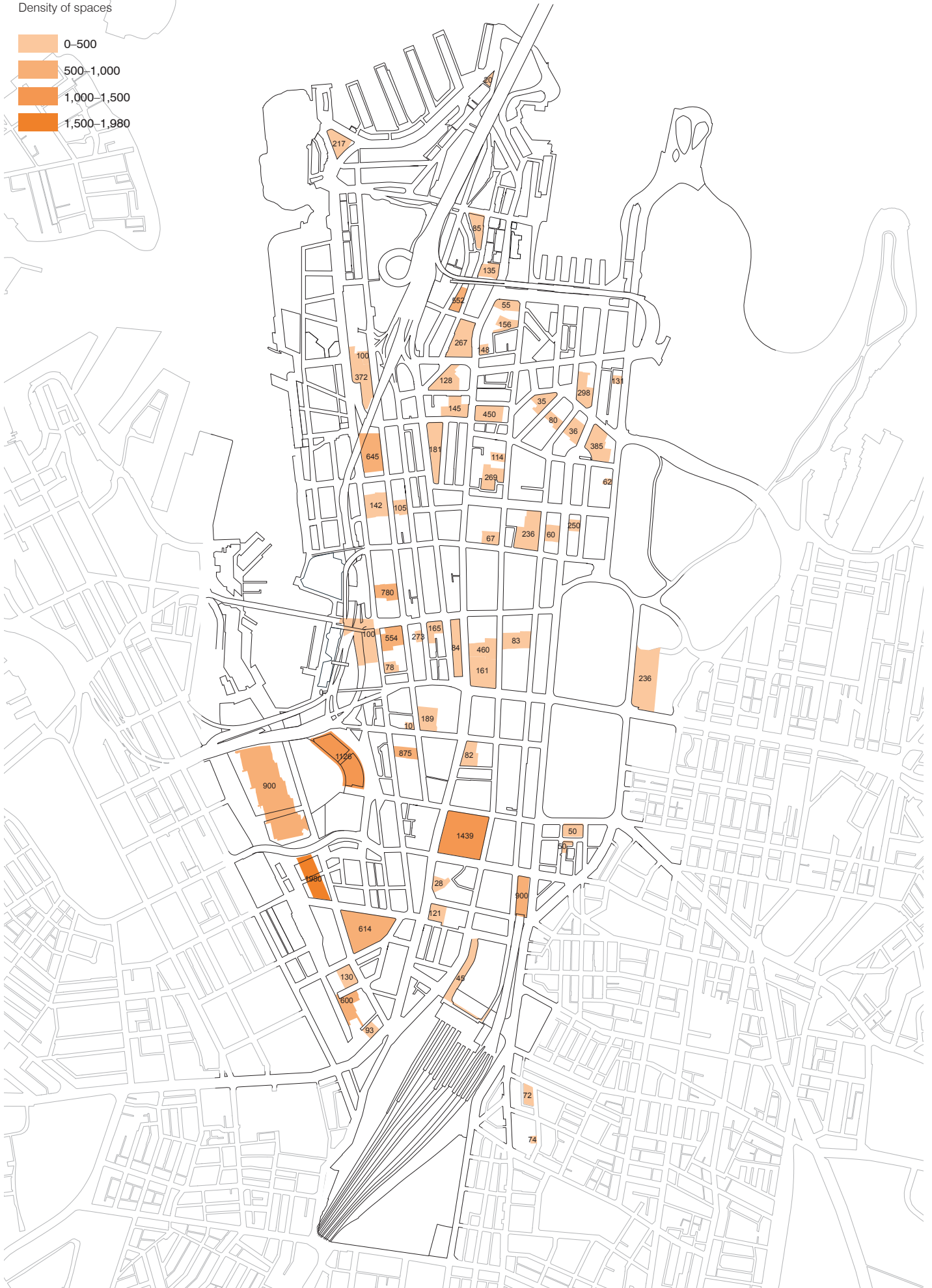
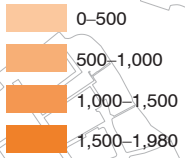

Transport links between open spaces

Another key issue for transportation infrastructure is linking open spaces. Individually, Central Sydney’s open spaces are significant but combined lack connection. The network of public spaces should be widened to encompass more and new significant spaces. Diverse walking links should be developed between them that can equitably be accessed by all, including people with a disability or with limited mobility. By doing so, Central Sydney can become a city of greater public life: a true city for people.

This has already occurred along the Sydney Harbour foreshore where the City of Sydney in collaboration with the State Government has progressively expanded opportunities for public access: a continuous walk is now possible all along the foreshore from Woolloomooloo to Barangaroo to Pyrmont and Glebe.

As described previously, Central Sydney is currently undergoing one of the most significant transformations since the 1971 Strategic Plan. The main George Street strip is being pedestrianised between Hunter and Bathurst streets and footpaths are being widened. George Street will be an inviting public space where people want to shop, visit and do business. Greater space for pedestrians along the street will mean cafes and restaurants can introduce outdoor dining areas.

The revamped George Street will become an easy way to travel between key attractions from The Rocks and Circular Quay to Central Sydney’s retail heart and down to Chinatown. Light rail will also link hotels to the renewed Sydney Convention and Exhibition Centre and three future major public squares at Circular Quay, Town Hall and Railway Square.

Beyond George Street, expanding the walking network between public places and improving the amenity of existing footpaths and pedestrian links will support sustainable growth in Central Sydney. A rich walking network with high amenity and many routes, links, crossings and connections will not only assist in addressing footpath capacity constraints, but will provide more choice and encourage more people to walk.

This has a range of social and economic benefits. It spreads the load of pedestrians, reducing strain on infrastructure; promotes community health and the reduction of obesity; creates opportunity for social interaction; and spurs economic activity by bringing people into new spaces. It also reduces the demand on public transport for short trips by reducing walking distances.

2_54

Open space characteristics and adequacy

	Core	West	Midtown	South
Provision of public space				
Small public places	Yes	No	No	No
Parks (large)	Yes	Yes	Yes	Yes
Sun-protected spaces	Yes	Yes	Yes	Yes
Connectivity to public space				
Directness	Yes	Yes	Yes	No
Slope/grade	Yes	No	Yes	Yes
Legibility	Yes	No	Yes	No
Fine-grain	Yes	No	No	Yes
Quality/pedestrian	Yes	No	No	No



Sydney Airport

Sydney Airport is arguably Australia's most significant transport infrastructure, facilitating the movement of more than 36 million passengers and 395,000 tonnes of international air freight annually. A daily A380 service from Dubai to Sydney, on an annual basis contributes an estimated \$342 million to Australia's gross domestic product and 4,400 jobs; a daily service from China to Sydney: \$388 million and 5,000 jobs.

While the Strategy and the City of Sydney have no part to play in the funding, growth or operation of Sydney Airport, the development potential for Central Sydney is directly influenced by its location, limitations and operations. It is therefore an important factor to consider in regard to Central Sydney's overall infrastructure.

Sydney (Kingsford-Smith) Airport is 7.8 kilometres south of Central Sydney and plays an important role in Central Sydney. It offers key competitive advantages and key components of metropolitan Sydney's ability to remain a global city through its safe and efficient operation, its proximity and connection to Central Sydney, and the role it plays as Australia's primary international transport hub.

Any physical obstructions, such as buildings, above the height levels of airspace operation have the potential to seriously limit the scope and efficient of operations in and out of Kingsford-Smith (refer to 2_57). For this reason, along with sun access, airspace operation levels form a key consideration that underpins the Strategy's approach to height. The City of Sydney, working in close consultation with aviation authorities, have sought to set height limits of buildings at maximum levels without penetrating any of the six airspace operation levels that apply to Central Sydney. With heights responding directly to these operation levels, increased certainty is provided to potential investors, developers and decision-makers around the feasibility of developments and expected outcomes.

Critically, where developments seek to maximise height, they must also address methods of construction. Temporary construction equipment, most typically tower cranes, are still considered a penetration of airspace operation levels. The likelihood that any penetration, temporary or not, is approved by aviation authorities and the City of Sydney is unlikely.

Constructing to the maximum heights requires innovation from the development industry. Constructing towers with spires, or masts, is probably the easiest way to construct to the maximum height without exceeding the height limit (and airspace operation levels) during construction. On the Petronas Towers in Malaysia, and the Burj Khalifa in Dubai, masts were constructed at a lower level, below the height limit, using cranes for the installation of material. Then the completed mast was jacked vertically into its permanent location. Flat-top towers will require a similar solution with the uppermost floors and roof constructed at a lower level and jacked into position when completed.

2_56

Cranes and their use within height constraints

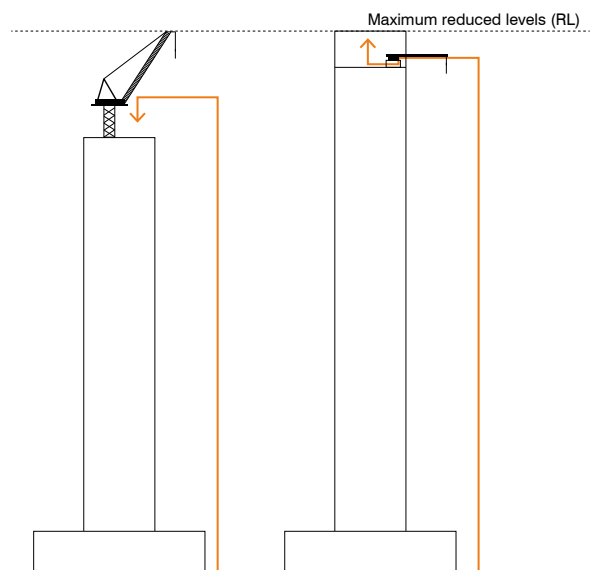

2_57

Prescribed air space for Sydney airport

Source: Sydney airport, 2015

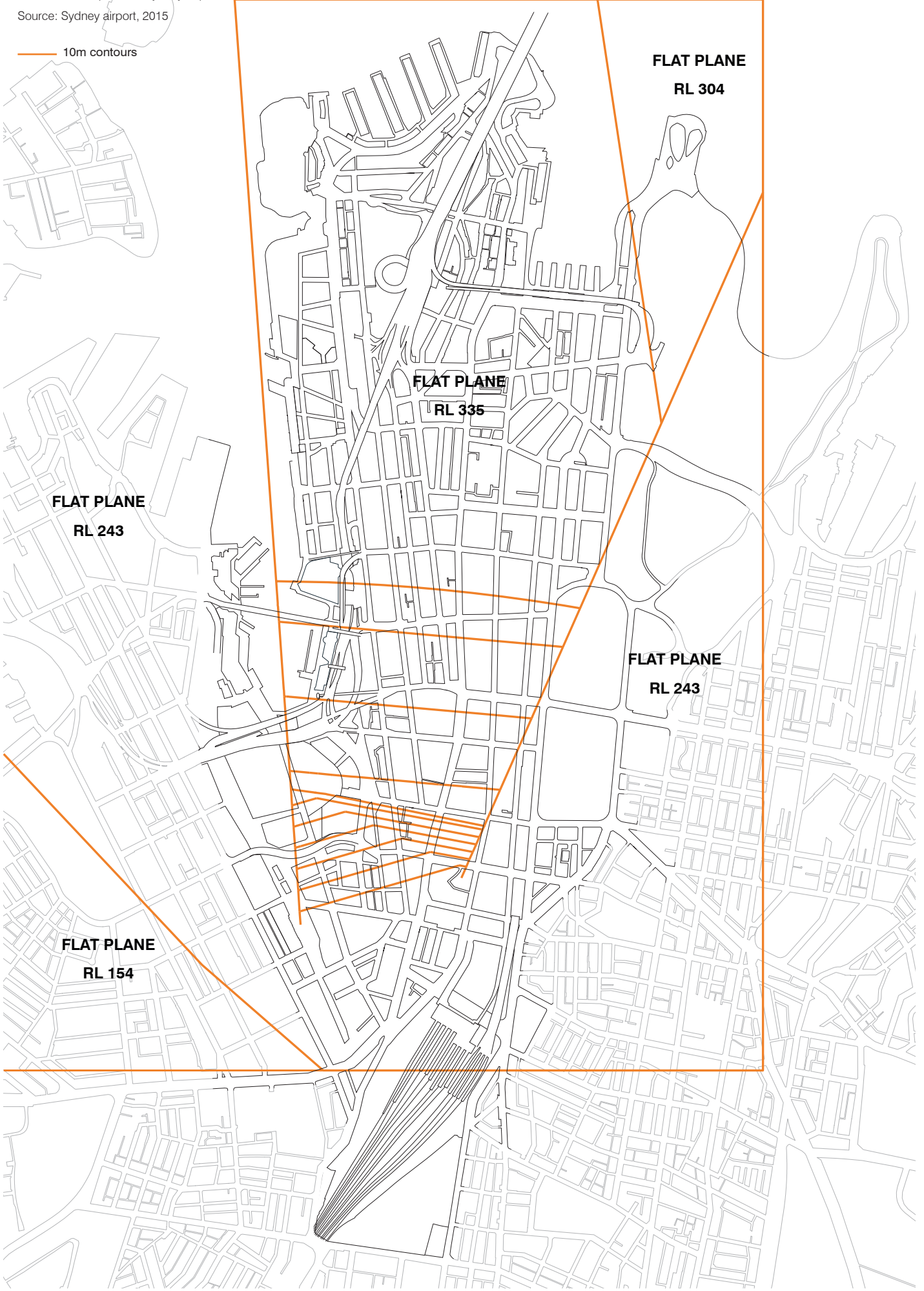

Community, cultural and social facilities

Central Sydney is the social centre of NSW. Its community and cultural facilities belong to all those that live and work in and visit Central Sydney. High-quality community and cultural facilities in Central Sydney are vital to metropolitan Sydney's regional identity and reputation as a liveable and dynamic global city. This cultural growth and economic diversity in turn supports metropolitan Sydney's ongoing competitiveness in the global economy, attracting investment and talent.

A person working in Sydney can run their entire daily life from Central Sydney. This is a huge part of why workers choose to work here – for the abundance of, access to and availability of local services and facilities. It is also why people choose to move here and visit – to take advantage of so many cultural and community facilities to suit their needs. With a daily population of over one million, the City of Sydney must ensure that Central Sydney's growing worker, residential and visitor populations continue to be well served into the future.

This can be accomplished by providing sufficient social infrastructure in the form of community and cultural facilities. These are vital to the fabric of urban life, community connectedness, and creating social capital and community resilience. They directly support the liveability of the Central Sydney and the wellbeing of its worker, visitor and residential communities. They provide spaces for Central Sydney's diverse communities to enjoy entertainment, creative and recreational pursuits, education and training, and rest and respite in a dense urban environment. And they also provide focal points for the community to come together, supporting a local sense of place and belonging.

Central Sydney does and needs to continue to provide a rich array of facilities that serve as catalysts for neighbourhood renewal and community development. These will help galvanise communities by creating opportunities for innovation, creativity and enterprise. One way to do this is supporting entry-level and start-up enterprises and other businesses through the provision of floor space, such as using planning controls to lower the cost of non-residential floor space.

Cultural facilities, such as museums and performance spaces, facilitate a creative, expressive and lively city, a city that people want to visit and spend time in. Well-designed community and cultural facilities can serve to activate high streets in the inner city, creating interest and vibrancy while complementing commercial and residential development. They can be catalysts for neighbourhood renewal and community development.

Central Sydney's community and cultural facilities such as libraries, community hubs and sporting facilities provide support, services and social and recreational opportunities to a broad cross-section of metropolitan Sydney's community. They are highly utilised and in some instances have difficulty in accommodating current demand. As Central Sydney's population grows at a high sustained rate, we are already seeing increased pressure on already very stretched community infrastructure such as libraries, recreation centres, health and education services, and associated community facilities that can be used for hire or programming for social programs and services. So, growth is needed in community and cultural facilities to cater to the commensurate growth in new residents, workers and visitors.

Child care facilities are under particular strain in the City of Sydney. The City's Child Care Needs Analysis Study 2013 concludes that a range of strategies are urgently needed to increase the supply of child care places to meet the current and growing shortfall, including increased delivery by the private and not-for-profit sectors.

Public toilets contribute to the quality of Central Sydney's public domain and its liveability. The aim of the City of Sydney's *Public Toilet Strategy 2014* is for a "highly regarded, safe and accessible network of public toilets to meet the current and future needs of a world-class city". With a daily population of over one million, the City of Sydney must ensure that Central Sydney's growing worker, residential and visitor populations continue to be well served into the future.

Key social infrastructure, such as primary and secondary schools and related child care facilities, healthcare facilities and emergency services, must be provided to support population growth in Central Sydney. The City of Sydney does not directly provide these services; most are provided by State government agencies. However, it plays a role in advocating on behalf of the community for the provision of adequate infrastructure.

"Opportunity spaces" – such as spaces for start-up enterprise or community organisations that encourage community development – enhance social, cultural and environmental programs and services and address community opportunities and needs. These spaces are available under the City of Sydney's accommodation grants program where the City leases community facilities or space within facilities at no charge or at a reduced rate. The City of Sydney can also work with industry and community to better support creative enterprises including through access to cultural facilities and equipment, studios and workshop spaces, and other types of facilities that provide avenues for increased creative participation.

2_58

Distribution of community and local service facilities

Internal area m² (2012)

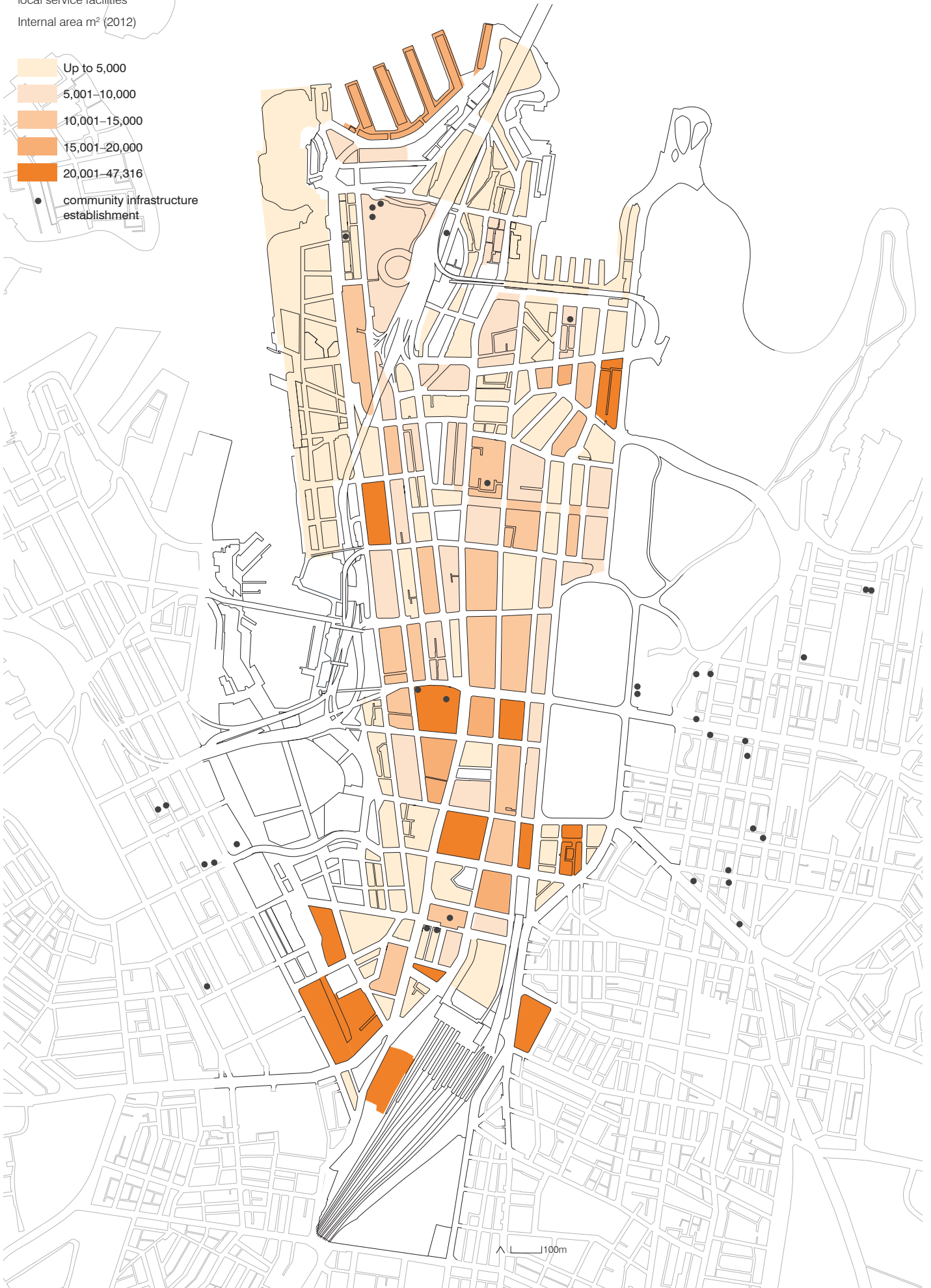
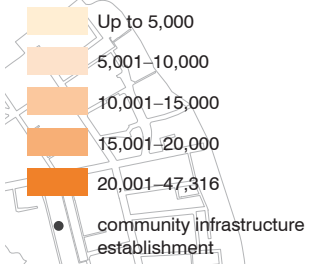

Affordable rental housing

The City of Sydney's Sustainable Sydney 2030 plan and its Affordable Rental Housing Strategy 2009–2014 establish an ambitious target that in 2030, 7.5 per cent of City of Sydney housing will be affordable. Currently, housing supply in the City of Sydney comprises 9.8 per cent social housing and 0.7 per cent affordable housing; about another 8,000 affordable housing dwellings are required to achieve the 7.5 per cent affordable housing target.

Affordable rental housing are dwellings for rent that are affordable to very low, low and moderate income households. These households typically comprise workers such as hospitality workers, young professionals, retail workers, and key support services. Affordable housing is not social housing. It can be private or publicly owned, but available at a price that is less than 30 per cent of household income. Because of the cost of private accommodation in Central Sydney, it is unlikely that affordable rental housing will be delivered by the market. Moreover, affordable accommodation will not necessarily be accessed by very low, low or moderate income households.

The gentrification of the City of Sydney and surrounds has exacerbated the relative inequality among those who can and cannot afford housing. In Central Sydney, the market is virtually inaccessible to those on very low to moderate incomes. These same people are increasingly forced out of surrounding City of Sydney suburbs, relocating to outer suburbs and commuting further distances for employment.

Where in 2011, Central Sydney's two most populous age groups were "tertiary education and independence age" and the "young workforce", by 2036 these two groups will proportionally decrease by 12 per cent replaced mostly by "parents and homebuilders", "empty nesters and retirees" and "seniors". This highlights a looming skills crisis for new and establishing business, not just a lack of direct access to a large student population and a highly mobile and educated young workforce, but a lack of access to well-staffed service industries – retail, food and beverage, and entertainment – that help them to attract workers from across the globe. This growing loss of lower-income households results in essential employment sectors finding it increasingly difficult to fill employment vacancies and staff shifts, hampering business productivity and economic growth.

Currently at around 50,000 employees, low income workers make up about 17 per cent of Central Sydney's workforce. With significant population growth expected in Central Sydney over the next 20 years, some of the jobs that will locate to Central Sydney will be for low-paid workers who are essential to our economy. In addition, a general demand for the services provided by low-income workers will increase as a result of more workers, residents and visitors.

The lack of provision of affordable housing also exacerbates the issue of people living in overcrowded, poor-quality housing. With a one-quarter rise in occupancy rates between 2007 and 2012 for sites south of Bathurst Street, the evidence suggests that with increasing demand to live close to Central Sydney, people are willing to compromise their living standards for the potential economic and social gains of living close to Central Sydney and its amenities. Planning for affordable housing in the City of Sydney for low-income earners is critical for the economic and socially sustainable growth of Central Sydney. Delivering affordable housing means providing housing for a diverse population with diverse needs, and is critically important in the creation of sufficient social infrastructure.

2_59

Change in median price by dwelling type, 2006 and 2014

Derived from Valuer General dwelling sale records, 2006 and 2014

	Area	Median prices 2006	Median prices 2014	% change in real price 2006–2014
Apartments	City of Sydney	\$533,200	\$700,000	31.3
	Metropolitan Sydney	\$477,400	\$575,000	20.4
Houses	City of Sydney	\$756,400	\$850,000	12.4
	Metropolitan Sydney	\$620,000	\$700,000	12.9

2_60

Change in median entry rents by dwelling type, 2006 (adjusted to \$2014)

State rental bond authority (NSW Fair Trading), 2014

	Area	Median rents 2006	Median rents 2014	% change in real rent 2006–2014
Apartments	City of Sydney	471	585	24.2
	Metropolitan Sydney	372	480	29
Houses	City of Sydney	533	690	29.4
	Metropolitan Sydney	372	500	34.4

2_61

Industry sectors employing greatest percentage of low-income workers in Central Sydney, 2011

Source: 2011 Australian Census

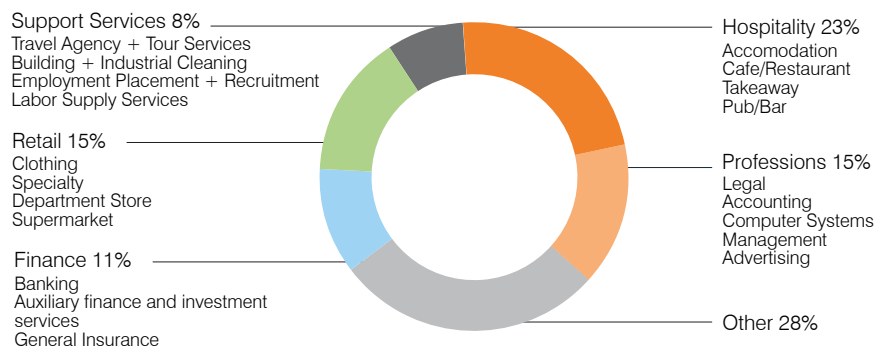

Energy, waste and water

Addressing climate change is our biggest global and local challenge. Cities have a critical role in reducing greenhouse gas emissions. This is because cities cover only 2 per cent of the Earth's land surface but have more than 50 per cent of the population and cause 75 per cent of the world's emissions. So, using energy infrastructure wisely and supporting alternate sources of energy is key to how Central Sydney contributes to these efforts.

Using energy efficiently saves precious resources, improves productivity and resilience, and maintains metropolitan Sydney's position as one of the most desirable cities to live and work in. It also results in substantial cost savings, necessary with the steep rise in energy prices in recent years. The City of Sydney is assisting the State deliver on its commitment to achieve an energy savings target of 16,000 gigawatt hours by 2020; at the same time, the City delivers its own vision for Central Sydney of a low-carbon city not reliant on coal-fired electricity. The results of energy efficiency initiatives in the City of Sydney can already be seen. Total electricity and gas consumption has fallen in recent years, reflecting the efforts of individuals and businesses.

This falling trend in energy consumption has occurred at the same time as rapid economic growth, with increases in employment, new businesses, jobs, new dwellings and floor area. Economic growth in Central Sydney is becoming decoupled from growth in energy use – a trend also observed elsewhere globally as efficiencies improve and energy usage behaviours change.

But the full potential for energy efficiency in Central Sydney will not be reached due to factors such as the split incentive (where landlords make investments while tenants gain the benefits), complex decision-making processes, and limited interest and access to capital. Intervention is needed; without it and with significant increases in floor space to accommodate Central Sydney's growing worker and residential populations, total energy use will increase.

Electricity demand forecasts for Inner Sydney (the Eastern Suburbs, City of Sydney, Botany and Marrickville) indicate that the need to address a shortfall in electricity capacity could vary from 2019 to 2023 (refer to 2_63). With nationally significant infrastructure – including Australia's financial hub, the Australian Stock Exchange, the heart of metropolitan Sydney's public transport network, Sydney Airport and Port Botany – as well as over 500,000 households and businesses located within the area, the need for initiatives to support the energy network are essential to delay committing to significant capital investment and to insulate metropolitan Sydney from the very real possibility of network outages, especially at peak usage.

Energy efficiency, along with local generation and demand response, has the significant potential to reduce peak demand in the electricity network, but only where that efficiency can be applied to offset energy use at peak times and locations. This is needed but may be difficult to achieve.

Each day, energy use rises and falls in line with people's activity at home and at work, creating a typical "load profile". In Inner Sydney, the electricity network peak is typically greatest in summer, between 11am and 8pm. The peaks are mostly driven by electric air conditioning systems which tend to be turned on at about the same time in response to rising temperatures, creating a "peaky" electricity demand profile.

The peak period for Central Sydney occurs when business peak energy demand overlaps with residential peak demand in the afternoon and early evenings. This is contrary to profiles of traditional energy demand, where mixed-use precincts are usually considered a good thing as the mix of user profiles enables demand to be spread across the day: from workers during the day and from residents in the evening. At the same time, Central Sydney's increasing daytime residential population of seniors, shift workers and stay-at-home workers means that residential users are increasing afternoon demand with an intensified peak of both worker and resident users between 4pm and 6pm.

Energy efficiency initiatives and local generation solutions reduce future pressure on electricity transmission and distribution networks. This in turn delays or avoids the need for investment in the networks based on the need to increase capacity, and reduces future upward pressure on electricity prices.

Central Sydney also has significant potential to reduce energy consumption as more than three-quarters of its total energy is consumed by non-premium office buildings, apartments, A-grade office buildings, hotel accommodation and car parks. The City, developers and building owners must work together to ensure that buildings incorporate designs that enable them to make use of networks and technologies that reduce utility usage and generation of waste to landfill. New buildings and renovation and extension of existing building stock should be highly water and energy efficient, and be designed with resource conservation and waste avoidance in mind, both in terms of selecting construction materials and controlling waste generation during the operational lifespan of buildings. A smarter, more sustainable Central Sydney will ensure the City stays a player on the world stage.

2_62

Gas and electricity consumption trend, City of Sydney LGA

Millions of gigajoules (GJ)

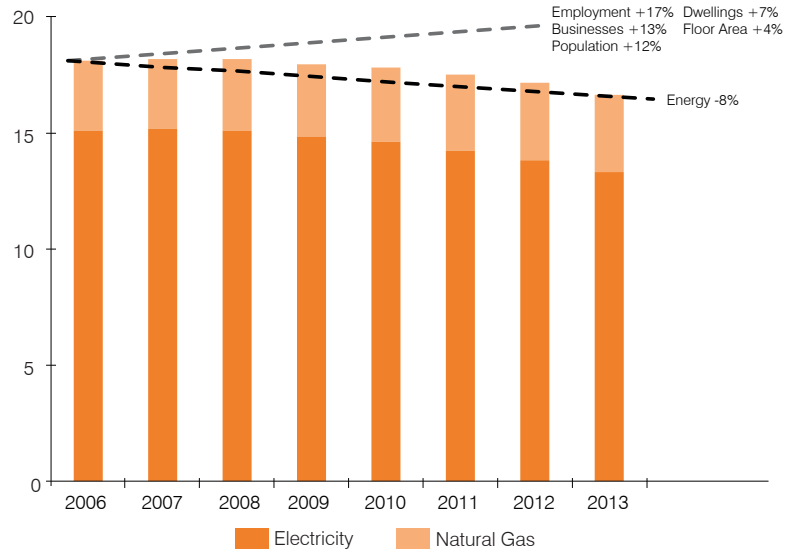

2_63

Electricity capacity demand for Inner Sydney

Electricity megawatts (mw)

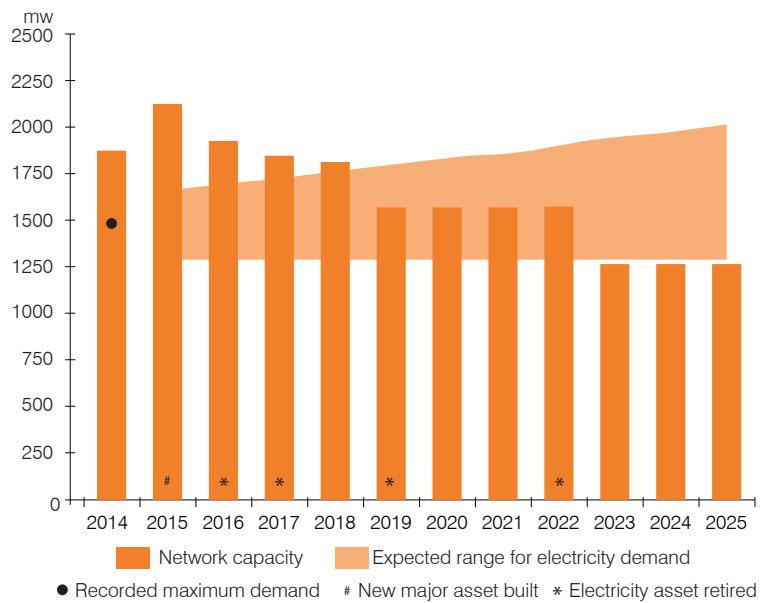

2.7

Land use

This sub-section describes development for land use in Central Sydney: office, residential, retail and visitor accommodation. While the provision of office floor space is crucial for Sydney's economy and status, the expansion of residential floor space has created challenges. Central Sydney's retail sector is dynamic and continues to contribute to a lively street life and economy, one which also attracts visitors. The Central Sydney Planning Strategy aims to strike a balance in land use that serves its people while ensuring that the mix of land use contributes to a city that is dynamic and world-class.

Meanwhile, to implement the Strategy, it is key to have a clear understanding of current property dynamics, and respond to them and shape them in a way that benefits Central Sydney. This sub-section discusses patterns of supply and demand, and how market conditions of Central Sydney's individual precincts may influence this in the future.

Market dynamics and the overall economy are difficult to predict and subject to influence by immeasurable local and global factors. A good understanding of what may occur, however, better equips the City to respond with a planning strategy that is positioned to deliver on its objectives, as well as those of the State, for Central Sydney.

Office floor space

Central Sydney is at the core of the metropolitan Sydney area and is a key attraction for investment, talent and economic productivity in Australia.

Local and international investors strongly favour Central Sydney as their preferred location for offices in Australia due to its size, and stable and durable returns on investment. It is not only the gateway to the rest of Australia, but with a similar time zone to China, Indonesia and Japan, can act as a gateway between the West and Asian markets. Central Sydney is viewed as a highly liquid, transparent and mature market, with a depth of tenants, particularly in the important financial services sector. With office tenants who expect and desire a continued presence in the Australian office market, with Central Sydney their favoured location, investment in offices will follow.

With more than one-third of all internal floor area in Central Sydney devoted to office floor space and more than four-fifths of workers in Central Sydney working in an office, the provision of office floor space and the future supply of office floor space is critical to the continuing success of metropolitan Sydney as Australia's only global city.

The location and position of office floor space in Central Sydney is not considered equal. The location preferences of investors and tenants drive office floor space investment. In Central Sydney, there are particular preferences to co-locate within existing industry clusters and institutions, to maximise views, and to be in close proximity to high amenity and iconic areas such as Martin Place, Sydney Harbour and Sydney Opera House. These assets drive investment in these areas, enhancing work environments, enabling businesses to attract and retain skilled workers. They also allow businesses to portray a global image to their workers and clients. Some industries prefer to locate near other institutions, for example the finance and legal industries are in close proximity to major institutions such as the Australian Stock Exchange and State courts.

Office investment in some other areas of Central Sydney is not as strong, with possible reasons including being too far from major institutions, a lack of industry peers, perceived poor accessibility, the lack of corporate amenity like views and public spaces, or the growing residential character of an area.

2_64

Central Sydney floor space by use

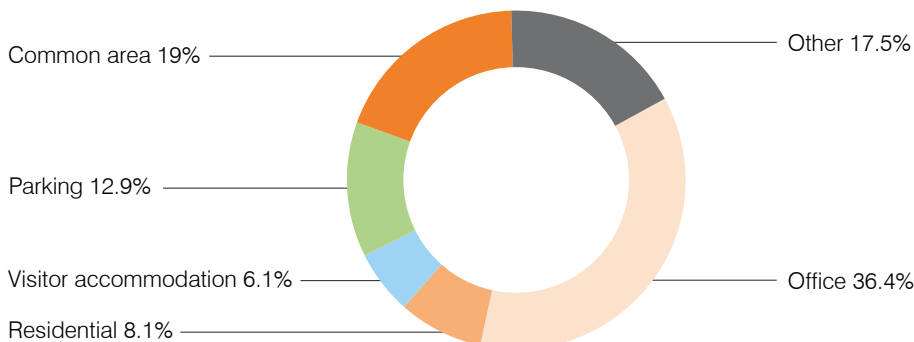

2_65

Total internal floor space by block m² (2012)

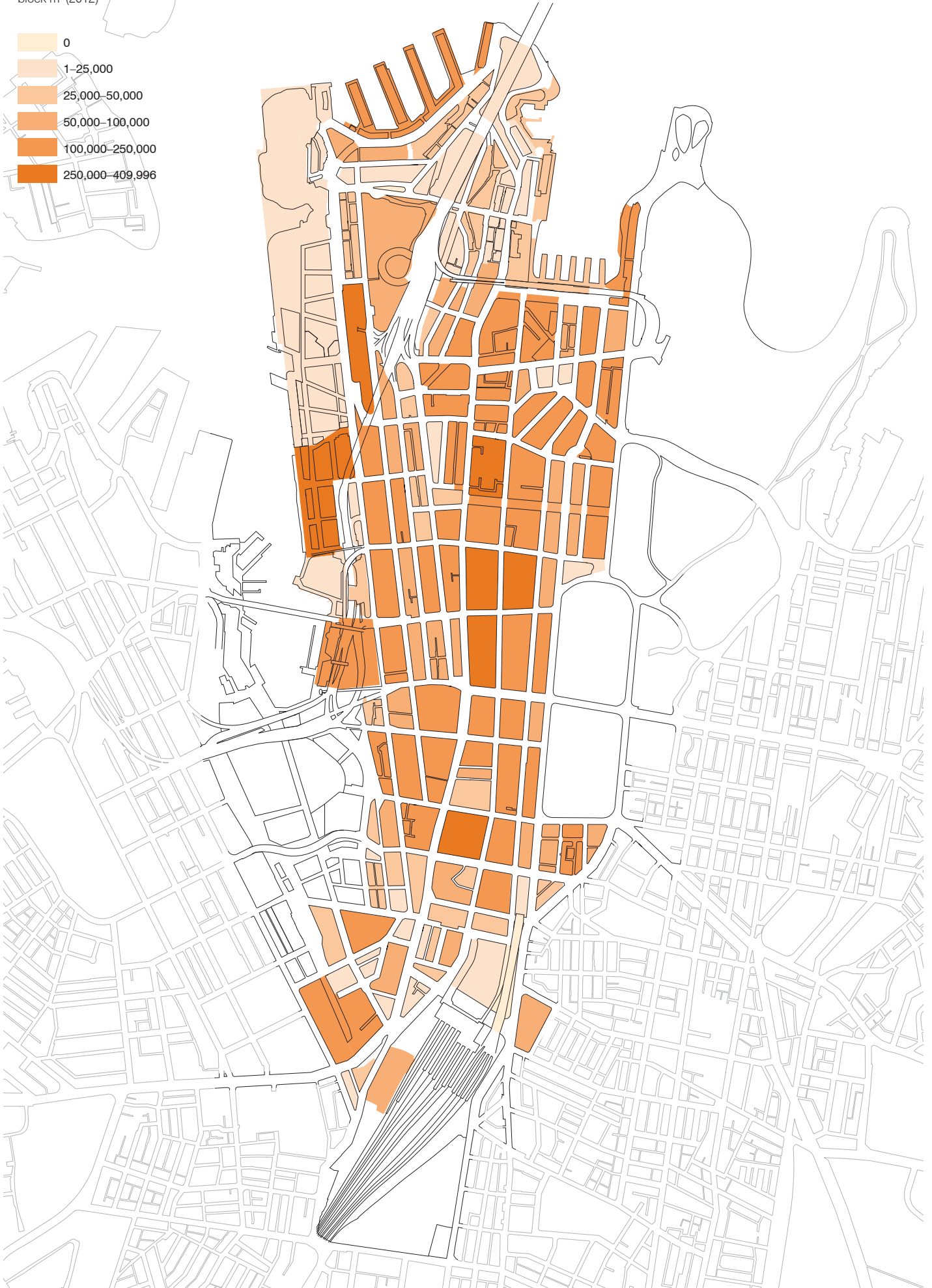
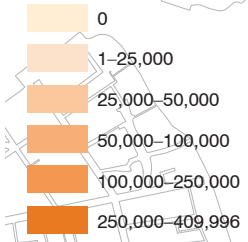

Office floor space trends

As demand for centrally located office floor space continues to rise in metropolitan Sydney, so too do commercial rents. Organisations are continually looking at ways to reduce costs and one emerging trend is the reduction of floor space assigned to each employee. This trend is partly a response to increasing spatial efficiency and keeping costs down but is also attributed to changing work patterns. Working from home and “hot-desking” (where employees are not assigned a personal desk, but rather share from a pool of work spaces) have both grown in popularity. As a consequence, floor space per employee in the Central Sydney core has gradually declined over the past 8 years, from an average of around 28 square metres per person to as low as 11 for open plan office environments (refer to 2_67 and 2_68).

This greater efficiency has been effectively funding higher-quality buildings and interiors while dampening outright demand for new floor space. This results in higher populations per building and greater transport demands. It is not clear that this trend will persist. However, in some key locations, such as Martin Place and the parts of the City Core with main harbour views, it has resulted in spectacular workplace rejuvenation.

Currently, new office space under construction or about to be constructed – 50 Bridge, 180 George, 200 George, 60 Martin Place and Barangaroo – is premium grade space with water views or Martin Place frontage. Very little lower grade or affordable office space is being built.

Central Sydney contains some of the highest job densities in the world. It is home to a significant proportion of service-related industry jobs including banking, legal, insurance and other professional services. Given the trend towards floor space consolidation per job, Central Sydney’s job density is likely to increase.

2_66

Central Sydney office market average net face rents

Source: Colliers International, 2015

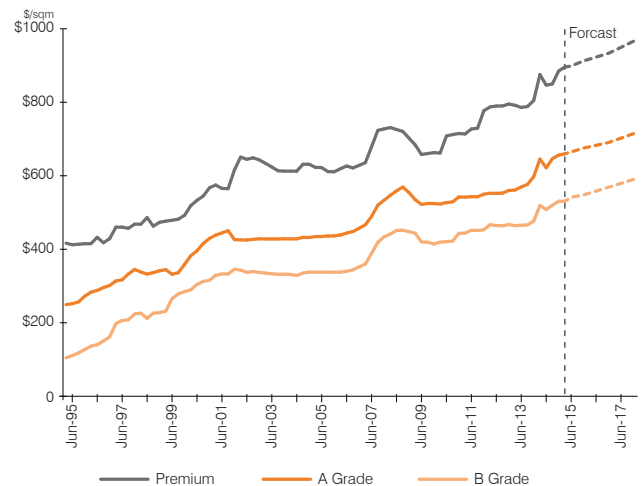

2_67

Occupied floor space per employee by selected use

Internal area m² (Central Sydney Traditional Core)

Use	1986	1991	1996	2001	2007	2012
Office	17.9	18.6	20.4	20.4	19.4	19.8
Shop/Showroom	29.8	28.1	23.9	24.3	25.5	23.7
Storage	305.6	367.4	271.6	284.9	298.7	295.4
Industrial	24.7	29	45.3	39.1	26.6	34.3
Leisure	216.4	224.2	150.3	145.1	219.6	182.5
Restaurant/Eating	30.2	32.8	25.0	25.2	24.9	22.8
Community	63.3	100.2	156.0	99.8	123.4	115.4
Net occupied space-use (excluding residential, parking and common areas)	22.7	23.5	26.1	28.4	24.1	24.2

Selected office type:

Partitioned office			17.7	17.5	14.7	14.6
Open plan			15.5	14.9	10.7	11.0

2_68

Occupied floor space per employee by selected industry

Internal area m² (Central Sydney Traditional Core)

Industry Division	1986	1991	1996	2001	2007	2012
Agriculture and mining	32.6	30.4	25.7	29.8	27.8	23.2
Manufacturing	26.0	25.6	19.7	19.4	23.1	19.6
Wholesale	29.0	25.2	26.6	26.9	26.4	24.2
Retail	35.4	34.9	28.9	27.2	32.1	30.0
Communication	25.0	32.9	26.6	28.9	27.1	27.0
Finance	20.6	22.6	22.6	22.0	18.4	18.5
Business services	19.2	20.5	21.4	20.7	19.6	19.6
Public administration	30.6	30.9	32.0	31.7	25.8	27.4
Community services	33.8	36.5	31.4	36.3	36.42	32.7
Net occupied business space	29.5	30.5	32.4	32.3	27.6	27.5

Agglomeration benefits

Locating in an area which has a higher density of economic activity (as measured by employment) allows firms to achieve economies of scale through access to an extensive customer base. This larger customer base presents opportunity to enterprises for economies of scope, i.e. with more clients, firms will be able to gain efficiencies by specialising in a particular field.

This process, called “agglomeration”, provides opportunities for firms to access a deep and diverse pool of skilled labour. With so many firms located together, there will be a high level of transfer of technology and knowledge between firms with much of the knowledge transfer provided by skilled labour moving between them. This will help bolster the innovation that is vital for firms to survive in a very competitive market place.

For urban centres, the benefits of agglomeration are multilayered. Centres that foster agglomeration and increase urban density promote innovation and productivity which in turn increases their economic output. An urban centre that fails to promote agglomeration is one that risks reducing its optimum economic capacity.

Multi-centre cities like metropolitan Sydney also benefit from agglomeration, but only where transport and technological connections between centres are continually invested in and enhanced. Investments and interventions in transport and technology can be used to shape cities, supporting the creation of employment nodes in strategic locations, and optimising a multi-centre city for agglomeration benefits.

2_69

Total land area by Effective Job Density
Source: SGS Economics and Planning

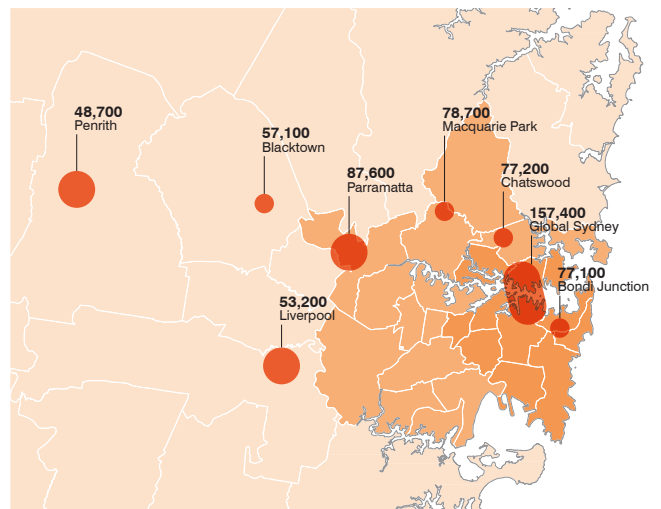
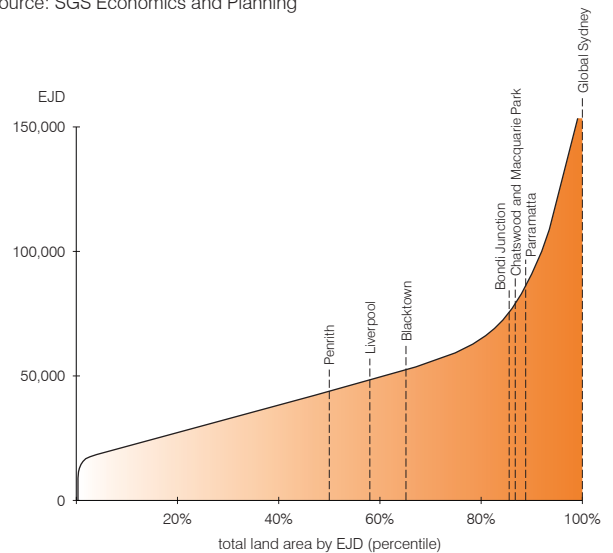

2_70

Office space - financial services
Internal area (m²)

- Up to 974
- 975-2,652
- 2,653-8,534
- 8,535-21,089
- 21,090-40,562

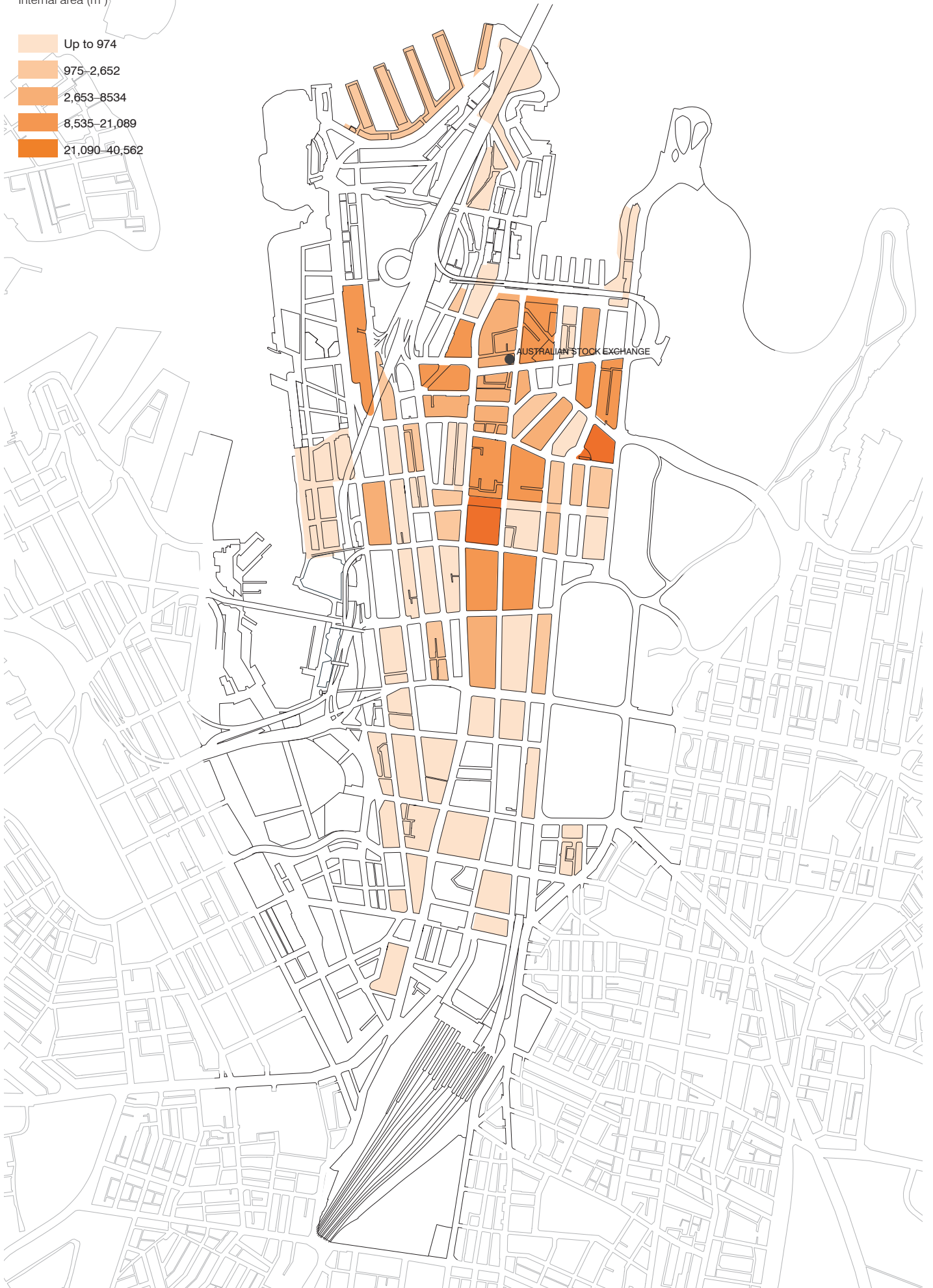

Residential floor space

Of Central Sydney's 800,000 square metres of land available for development, residential strata development occupied 24 per cent in 2015 (a huge increase from 2 per cent in 1991). In 2012, residential floor area represented 10 per cent of Central Sydney's total built floor area though a much greater proportion of land area.

The lead up to and aftermath of the 2000 Olympic games represented the biggest period for residential strata registration in Central Sydney since 1964: 60 schemes were registered between 1998 and 2005. The largest year for residential strata registrations was 2013 when 12 new schemes were registered (refer to 2_71).

Since 2012, 25 new residential apartment proposals have been approved within Central Sydney, not including State-significant development approvals including residential within and around Central Sydney. The 25 approved residential strata schemes represent an increase in occupation of Central Sydney's total land available for development from 24 per cent in 2015 to 28 per cent. They represent over 308,000 square metres of approved residential floor space, over 3,000 apartments and, on average, 102 square metres per apartment. They also represent a net loss of close to 130,000 square metres in existing employment floor space that are to be demolished to make way for the strata schemes, and 285,000 square metres in potential employment floor space that will instead be utilised for residential purposes. Of the 25 proposals, 15 were approved in 2015 alone, representing the largest growth in residential strata since 2003 and the largest recorded period of residential strata growth since 1971.

2_71

Residential strata units over time

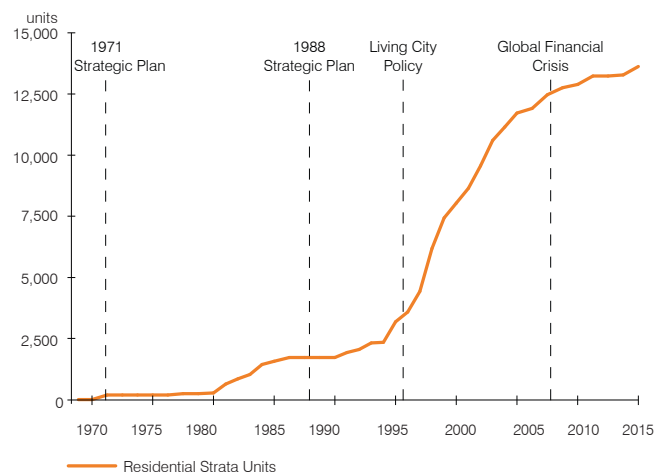

2_72

Residential strata over time

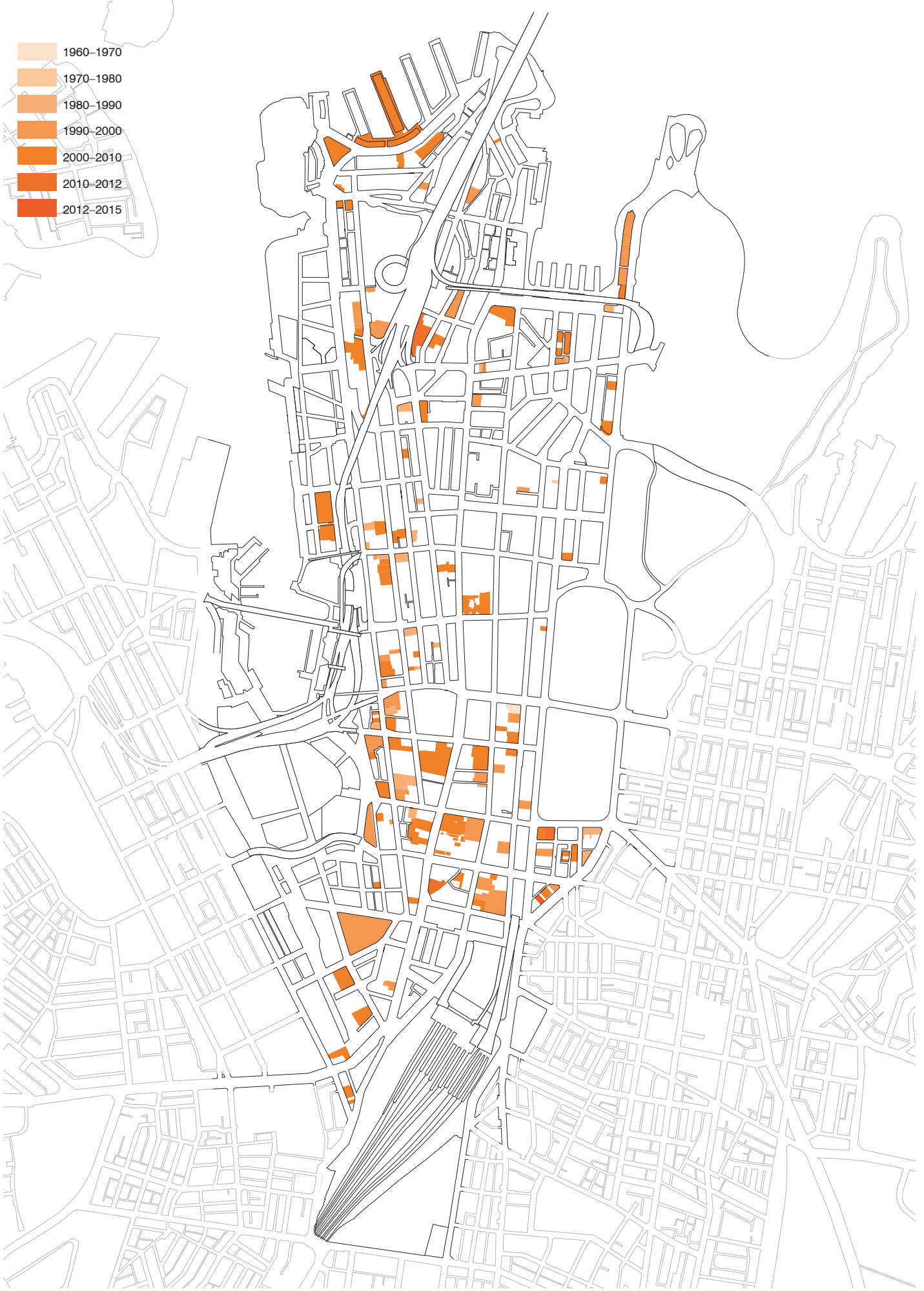

Residential floor space trends

The key trend in residential floor space in Central Sydney is that it is being approved in a variety of forms, from tiny sites of 230 square metres to some of the largest sites in Central Sydney of over 4000 square metres. Larger sites used to be reserved mainly for office development, but this is no longer the case. Residential developments are also being approved in smaller sites, reflecting that these projects don't require a lot in terms of physical site requirements. They can be accommodated on sites of any size or dimension, with less costly amalgamations and small tower floor plates. This contrasts with standalone offices that face too many challenges to develop on small sites.

The average apartment mix across all recent residential approved developments was 40% studio and one-bedroom apartments, 43% two-bedroom apartments and 17% apartments of three bedrooms or more. The characteristics of residential dwellings have a direct influence on an urban centre's social fabric. It determines who lives there, and therefore forms part of the character of the urban centre. By having a typically higher proportion of apartments three bedrooms or more than other urban centres, Central Sydney's residential developments should cater well in the future for families. This aligns with the projected future increased growth of parents and homebuilders in the area.

However, larger apartments and a lower proportion of smaller apartments typically means housing options are less affordable for Central Sydney's key workers, students and young workforce that are so critical to the economic prosperity of metropolitan Sydney.

It is unfortunately difficult to predict changes in Central Sydney's demographics based on apartment approvals, although it is currently the most useful indicator. Accurate data is currently unavailable of the current or predicted share of apartments in buildings occupied by owner-occupiers and renters, and whether apartments are purchased only for investment or holiday stays and left vacant for the majority of the year.

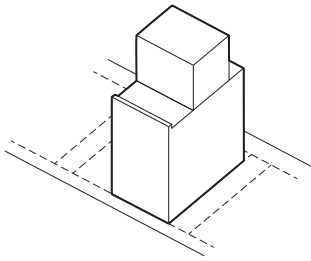

Residential on small sites

- Very rarely require amalgamations
- An average site area of 495 square metres
- An average height of 58.25 square metres
- Generally comply with primary street frontage heights
- Most have a laneway or secondary street frontage
- An average approved overall FSR of 10.6:1
- Where no car park access or loading was proposed, ground floor activation is always graded as 'active'
- Where car park access or loading was approved, ground floor activation is always graded as 'inactive'

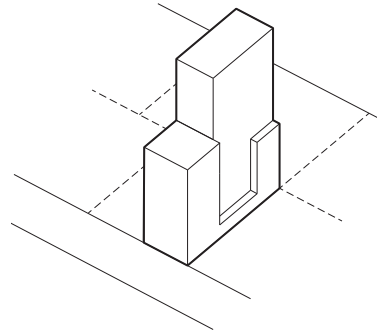

A typical stand-alone hotel development

- Typically don't require amalgamations
- Average site area of 615 square metres
- An average height of 42.5 metres
- Typically no laneway or secondary frontage
- Never secondary frontage
- Typical FSR of 10.8:1
- No loading or car parking – always passes activation test
- Average number of 110 rooms.

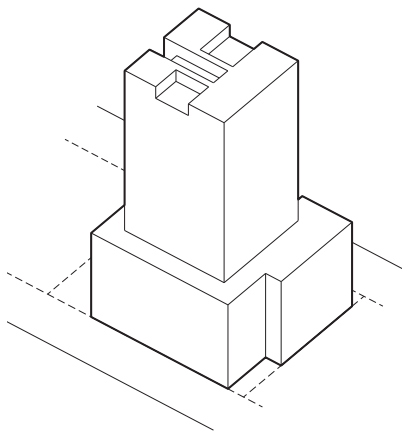

Typical office development

- The average site area for office only developments is 3,776 square metres
- More than half required consolidation of two or more sites
- An average height of 147 metres
- Generally comply with primary street frontage height controls
- Never have a laneway frontage
- All have a secondary frontage
- Average approved overall FSR of 14:1
- All propose on-site car parking
- All approvals have active ground floor frontages
- Average tower floor plate was 1,611 square metres in size
- All have eccentric lift/service cores.

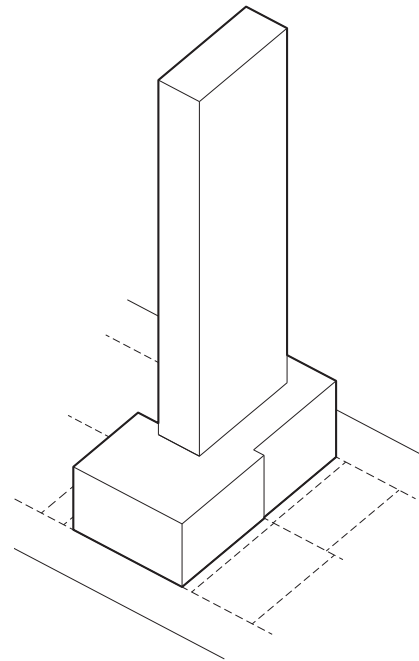

Residential on larger sites

- More than half required consolidation of two or more sites
- An average site area of 1,783 square metres
- An average height of 116 metres
- Most have a secondary frontage
- An average approved overall FSR of 12.6:1
- All propose on-site car parking
- The average site area for approvals with an "active" frontage is 2238 square metres
- The average site area for approvals with an "inactive" frontage is 1352 square metres
- Average tower floor plate of 770 square metres.

Retail

Central Sydney is metropolitan Sydney's premier retail location. Home to one-third of the City of Sydney's retail premises, its diverse retail offering not only caters for those who live and work here but also for Central Sydney's many visitors. In 2012, it is estimated that the retail sector contributed \$1.8 billion to the city economy.

Tourism, culture, leisure, retail, personal services and food and drink premises account for approximately 17 per cent of Central Sydney's workforce and provide employment opportunities for a broad level of skills. These sectors are still growing with some 8,000 more jobs in 2012 than in 2007. Two-thirds of the people who work in these industries live in the City of Sydney, reflecting in large part the similarities in age profile between Central Sydney's resident community and that sector's younger workforce.

Central Sydney's retail core has shifted over the years, largely related to the location of major train stations. It is now located around Pitt Street Mall. This area, and to the west, has perhaps the best solar access to streets in Central Sydney.

The strength of the retail sector Sydney can be measured by the success of projects like Westfield Centrepoin and MidCity Centre, with their completion notable despite economic conditions at the time. It is because of these projects and an increase in pedestrian traffic that Pitt Street Mall maintains its position as one of the five most expensive retail streets in the world.

Between 2007 and 2012, the number of businesses in the Central Sydney increased by 5.6 per cent, from 10,688 to 11,287 establishments. The second-largest sectoral increase occurred in the food and drink sector with 181 additional businesses. Patterns of growth for the retail core have started to emerge with the Western Edge attracting more niche retail and restaurant offerings.

To strengthen the retail sector, the City of Sydney has focused on enhancing the experience of shoppers through investment in high-quality places and infrastructure. The pedestrianisation of George Street and the introduction of light rail will reinforce George Street as the main transport corridor for pedestrians in the city and will open up better street-level business opportunities.

Meanwhile, international brands new to Australia are being drawn to Central Sydney, seeking flagship store locations. These stores are introducing two-storey plus retail frontages to Central Sydney's retail strips, as well as elevated awnings and digital signage that risk redefining the pedestrian experience of the street.

Smaller retailers are taking advantage of planning incentives and City of Sydney investments – like the Chinatown Public Domain upgrade with new paving, stormwater works, public seating and new landscaping – to occupy laneway tenancies and in turn provide greater depth to Central Sydney's retail experience.





Central Sydney's character and street-level experience is fast becoming its biggest advantage in setting it apart from other cities; and the benefits associated are complementary for residents, tourists and workers alike. Each group is a vital part of Central Sydney's economic base and provides a unique contribution to its vibrancy, connectedness and dynamism. For instance, supporting greater entertainment-based services, especially during weeknights, not only benefits residents but can also contribute to improving the city's overall tourism potential. More commercially focused cultural and night-time activity – such as at live music venues, clubs, restaurants, licensed premises and small bars – is an essential part of maintaining a competitive Central Sydney that attracts tourists, workers and future City of Sydney residents.

Retailing will continue to evolve and continue to be influenced by a broad spectrum of market influences ranging from an ageing population and internet retailing to Sydney's student population and the strength of the Australian dollar. However, demand for retail space in Central Sydney is expected to remain strong due to the desire to be among newly redeveloped office accommodation, and by extension, closer to consumers.

2_73

Distribution of retail services

Internal area (m²)

-  Up to 1,000
-  1,000–10,000
-  10,000–20,000
-  20,000–40,000
-  40,000–83,000

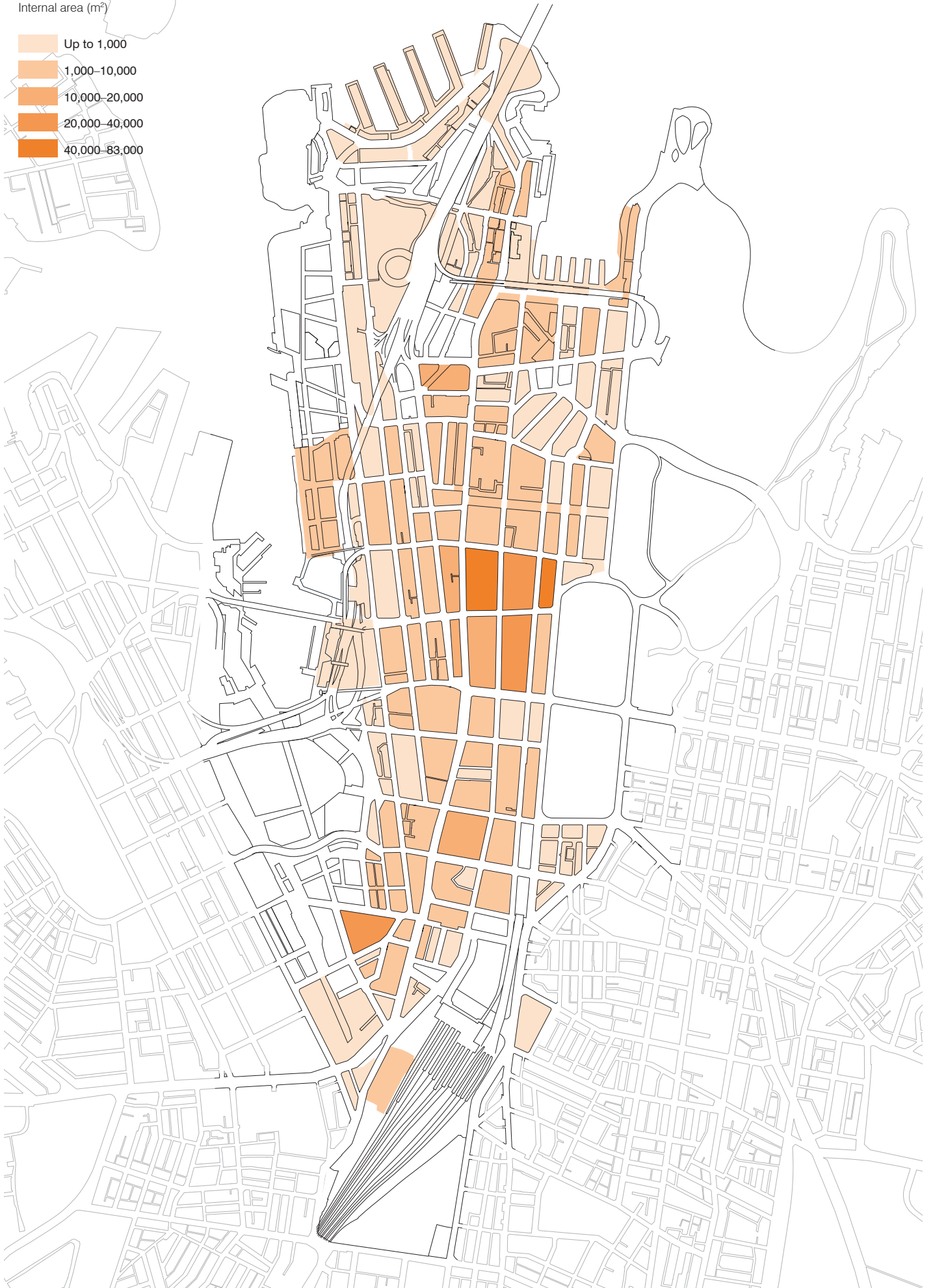

Visitor accommodation

Visitors contributed over \$5 billion to the economy in 2012, and for every dollar spent on tourism an extra 91 cents is spent in other parts of the economy. This is a multiplier effect higher than the mining, agriculture and financial services sectors.

Many of Sydney's major hotels were developed from the mid-to late 1980s. Japanese investors and local entrepreneurs were encouraged by optimistic views of future demand, financial sector deregulation and an expansionary monetary policy.

Development stalled in the early to mid-1990s with the recession of 1991–92 and the number of rooms decreased slightly. Construction resumed in the late 1990s driven by improved sentiment around international visitors and investment in preparation for the Olympics. The City offered development incentives until 1998 for hotels and serviced apartments opening in time for the Olympics. From 1996 to 2000, the City's room stock grew by 50 per cent from about 14,350 to 21,550, including a number of new five-star hotels.

Development activity slowed from 2001 and the number of rooms decreased as the pre-Olympic supply was absorbed. The residential market was on the upswing and many hotels were converted.

Construction costs increased significantly from the mid-2000s, hampering new development. Except for serviced apartments in Central Sydney's south, there were few new projects due to a large feasibility gap and little infrastructure investment to drive demand.

The global financial crisis held back a recovery in the late 2000s but strong trading in recent years has led to the planning of new accommodation. Since early 2014, the City of Sydney has approved and received development applications for over 60 hotel proposals, including new rooms in 20 mixed-use developments, 9 new stand-alone hotels and over 30 hotel refurbishments. That is equivalent to over 3 billion dollars of development, over 4,600 new hotel rooms and

over 200 new serviced apartments. More than 80 per cent of these rooms are to be delivered in Central Sydney, driven by development at Darling Harbour and Barangaroo. Time will tell if all developments progress to construction. However, these figures indicate the largest increase in visitor accommodation for the City of Sydney since the pre-Olympic period.

Over the past decade, the annual number of visitors staying in city hotels has increased by nearly 1 million and these numbers are expected to grow. Room night demand will continue to grow with softer growth to 2017 then increasing to 2021 with the opening of the Sydney International Convention Exhibition and Entertainment Precinct and Barangaroo from 2017.

Visitor growth is expected to be driven by international visitors, particularly from Asia and most notably China as they shift from group travel to independent business and leisure travel. Growth from Japan, New Zealand, the United Kingdom and North America will be slower. Domestic visitor growth will not be as strong but will be led by the business segment.

Demand will be strongest in the three-star category, assuming the conversion of old office building stock in the city centre and changes in the profile and preferences of international visitors.

It is forecast that accommodation room supply will increase by 5,759 rooms to 2021 and then by 5,499 rooms from 2022 to 2030. Supply will peak through 2018 to 2020 before falling back with another development cycle towards the late 2020s.

2_74

Visitor accomodation
Number of rooms

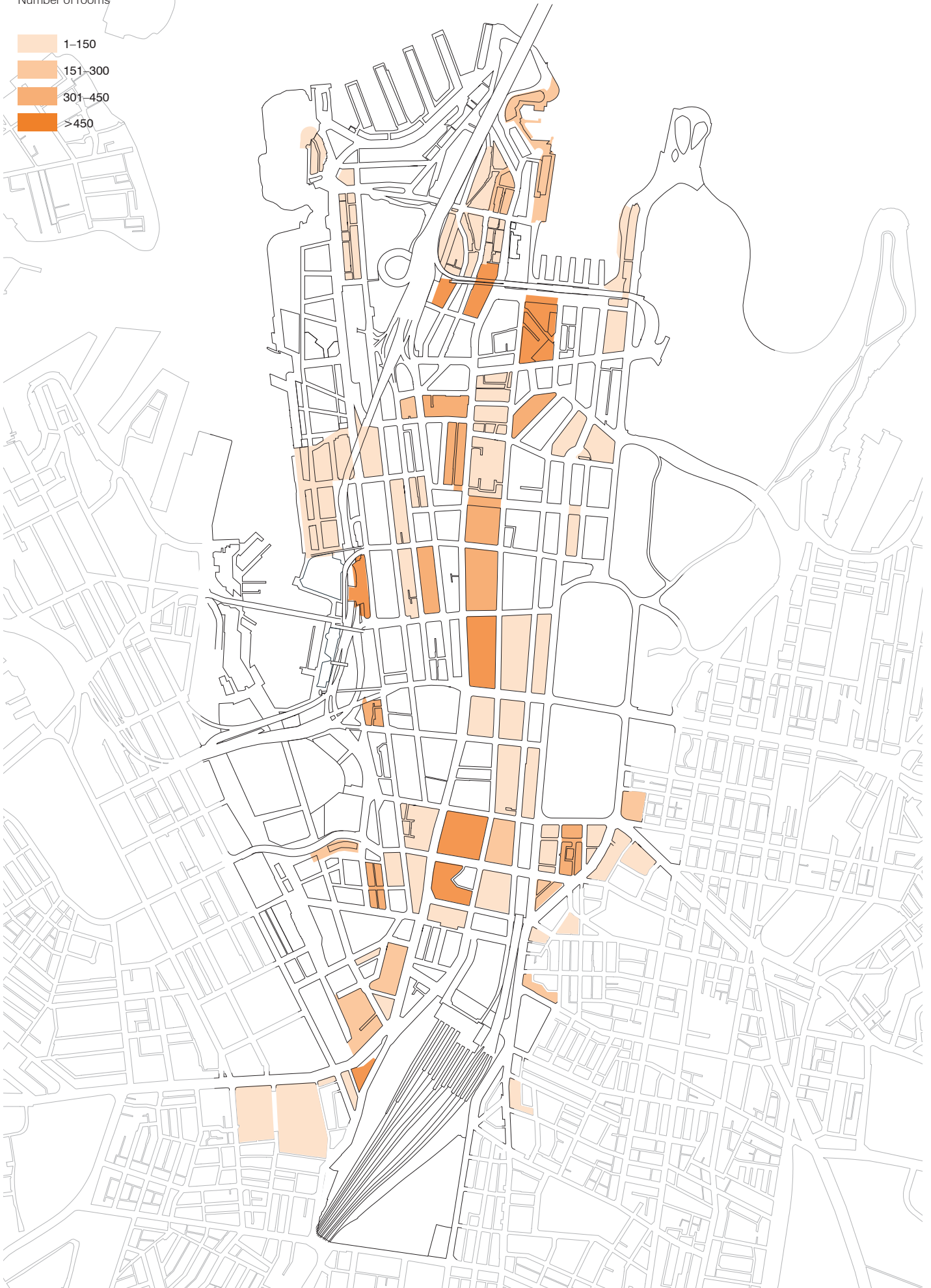

Development use trends

Patterns of supply and demand in the property market are critical as they underscore Central Sydney's ability to accommodate present and future demand for floor space.

There is strong market demand for a variety of floor space types across Central Sydney. A tension between land uses is therefore inevitable. Furthermore, the rejuvenation and revitalisation of prominent parts of Central Sydney such as Barangaroo and Darling Harbour, coupled with major infrastructure projects such as George Street Light Rail and Sydney Metro, will undoubtedly increase Central Sydney's overall attractiveness as a place to live, work and play. Over the past years, Central Sydney has undergone a significant transition. Mixed use and residential towers are increasingly featured in its skyline. This trend has peaked over the last three years with the market aggressively favouring residential development over office development. This phenomenon is encouraged by current land use policies that promote residential development, specifically the allocation of Accommodation Floor Space for residential purposes. The trend is a product of both a historical under-provision of dwellings and an awakening to the benefits of CBD living.

Central Sydney's work, social and cultural offerings represent a compelling proposition for a range of residential occupants, from younger residents to families and empty nesters. The trend of increased residential development activity has resulted in a number of marginal commercial assets acquired by overseas investors for long-term residential developments. Changes in house prices may cause developers to delay residential development, but is unlikely to reverse strong residential demand in Central Sydney.

While today's commercial market varies significantly across the various precincts in Central Sydney, its strong demand for A-grade space has resulted in the difference narrowing between Premium (landmark buildings located in close proximity to major economic markets, with expansive views, ample natural light and attractive street settings) and A-grade (high-quality buildings with high-quality views, natural light and an attractive street setting) rents; both types of space are experiencing falling vacancy rates.

A number of key factors drive the expectation that the current strong market demand for commercial development will endure in the short to medium term, including:

- The economy is growing and employment rising in the Sydney metropolitan area.
- Employment growth projections for Central Sydney indicate sustained growth in white-collar employment to 2025.
- There is an ongoing trend towards centralisation of headquarters with demand from those occupiers seeking to attract and retain talent.
- The withdrawal of commercial floor space for alternate uses, including residential and the future construction of Sydney Metro, puts pressure on the remaining supply.

An undersupply of retail floor space in Central Sydney has increased the demand for opportunities to create additional retail floor space in other locations, including within office buildings. Many owners have responded by reinvigorating their ground floor retail offering to include a diverse retail mix. However, retail floor space (unless within a shopping centre) does not generally respond to density and height in the way that commercial and residential uses do, as more floor space away from the high street is not seen as valuable. As a consequence, the growth in retail floor space is generally confined to the podiums of new buildings.

Reflected in high occupancy rates and growth in room rates, the demand for space in the hotel and accommodation sector is strong. Currently however, the large-scale development of new hotels is not financially feasible unless part of a mixed-use development. At the same time, new hotel rooms and serviced apartments are being created in the Western Edge and Southern precincts that can accommodate them with more modest site values.

Trends by precinct and surrounds

Central Sydney is Australia's largest and most robust office market with 53 per cent of its total floor space rated as prime commercial floor space (premium and A-grade) by the Property Council of Australia. It is comprised of a number of sub-markets, each with distinct characteristics, drivers and opportunities for future growth. The sub-markets generally align with Central Sydney's precincts.

City Core

The City Core comprises the largest office sub-market in Australia. It is the most sought-after location in Central Sydney, favoured by the financial, legal, property and technology sectors. Over 65 per cent of people working in the City Core work in financial and insurance services and professional, scientific and technical services.

The City Core contains the largest number of premium buildings in Central Sydney and the most commercial floor space, which in turn facilitates greater volumes of commercial development. It also commands the highest rents.

Major tenants in the City Core include: AMP, ANZ, Australian Stock Exchange, Charter Hall, Clayton Utz, DEXUS, Deloitte Australia, DLA Piper, Henry Davis York, HSBC, Macquarie Bank, Mirvac, NAB, QIC, Reserve Bank of Australia and Suncorp. Ernst and Young will be relocating into the City Core from Midtown in 2016 upon completion of 200 George Street.

Due to the profile of occupants, premium-grade floor space and large office floor plates (greater than 1,200 square metres) have traditionally been highly sought after. Notwithstanding, smaller tenancies are increasing in prominence as the trends continue of outsourcing and growth in the technology sector.

In line with its status as metropolitan Sydney's most prestigious office sub-market, the quality of tenant amenity and the public domain is critical for the precinct to maintain its status and market position. Land-use conflicts, for example visible residential balconies and drying laundry, if not managed appropriately, have the potential to erode the City Core's premium status and overall desirability as a commercial precinct.

In line with the reinvention of Martin Place, this precinct is expected to see continued growth in its major industry sectors, and will accordingly demand larger floor plates and premium-grade quality accommodation.

Midtown

Midtown is predominantly composed of A and B-grade floor space and is more affordable compared to the City Core, and offers good accessibility, retail and entertainment options.

Midtown's employment profile is more diverse than the City Core and the Western Edge. Employment in professional, scientific and technical services is just over 20 per cent of the total, with employment in financial and insurance services around 15 per cent, public administration and safety, and information media and telecommunications, both at around 12 per cent.

The availability of premium commercial development opportunities is limited, given the generally lower amenity of the area, particularly south of Bathurst Street. While A-grade commercial development is still relatively attractive, in today's market, mixed-use development is an attractive proposition for residential developers.

Midtown's commercial supply pipeline is the smallest compared to the City Core and the Western Edge. In contrast, there is significant mixed use and residential development activity ongoing in Midtown, resulting from the comparatively generous accommodation floor space provisions for residential uses. The relatively high amount of residential development has seen some commercial buildings, such as the site of Sydney Water, withdrawn for residential conversion. The effect has been a dilution of the remaining commercial floor space as the area has become more mixed-use.

Smaller tenants dominate the tenancy profile in Midtown, although major commercial occupiers include the Australian Taxation Office and the City of Sydney.

Demand for finer-grain office floor space (tenancies smaller than 500 square metres) is expected to continue in Midtown. The depth of the market for smaller tenancies is greater than that for large floor plates, but is generally less well catered for by new developments that require large pre-commitments to commence.

The outlook for the precinct is good; however, it suffers in some parts from amenity challenges which can detract from investor and occupier interest.

Western Edge

The Midtown and Western Edge precincts are broadly similar in size and scale, each accounting for some 24 per cent of Central Sydney's office floor space.

The Western Edge's employment profile bears similarities to that of the City Core. It is also dominated by financial and insurance services and professional, scientific and technical services which together represent almost 65 per cent of employment in the precinct.

The availability of premium commercial development opportunities is limited in the Western Edge. Today's market steadily favours residential development over commercial. This is particularly the case where westward harbour views are available; where a site offers more modest views, commercial development becomes more viable.

While Midtown has traditionally been perceived in the market as marginally more desirable (denoted by higher rents and capital values), Darling Park, the development of Westpac's headquarters on Kent Street, and most recently Barangaroo have cumulatively improved the overall amenity of the Western Edge and lifted its market profile. Commercial rents and capital values are broadly on par; Midtown is only slightly ahead.

Southern

The Southern precinct is a comparatively minor office precinct, accounting for only 7 per cent of the total office floor space in Central Sydney. The precinct is anchored by Chinatown in the north and Central Station in the south where many government back-office functions are located. Large numbers of residential strata developments are located here.

The precinct accommodates a large number of public administration and safety jobs (nearly 25 per cent) and almost equal proportions of accommodation and food services (13 per cent); transport, postal and warehousing (13 per cent); and professional, scientific and technical services (12 per cent).

The Southern precinct's current mix of tenants and image are not likely to appeal to large corporate occupiers. The precinct is generally characterised by low turnover of tenants and offers no premium floor space. Affordable rents and the availability of large floor plates towards the south of the precinct appeal to occupiers for back-office functions and those who seek cheaper accommodation; this is likely to continue.

As such, the Southern precinct is unlikely to witness commercial-only development, particularly in the northern part of the precinct in and around the entertainment areas and Chinatown. Any development in this part of the precinct is likely to be mixed use in nature.

In many parts of the precinct with vibrant retail and entertainment options, the existing occupier patterns are generally more fine-grained in nature. Demand for commercial floor space is likely to be smaller and incorporate occupiers responding to a local population catchment, i.e. residents in the precinct and the large number of students living in close proximity to the University of Technology Sydney and the University of Sydney.

There is currently no new commercial office development in the pipeline for the Southern precinct and while several mixed-use developments are underway, the scale of residential development activity is minor in comparison to the other precincts.

The low levels of commercial development activity reflect the low value of office use in the area, both in terms of rents as well as the relative attractiveness of the area to major private occupiers. This does not incentivise developers to construct new offices in the Southern precinct in the current market.

South Ultimo

The area of South Ultimo is not within the current Central Sydney boundaries, though it does have a significant commercial presence and accommodates residential, retail and hotel uses.

In 2011, the area employed almost 13,000 people. It grew in employment by more than 18 per cent in 2006–2011. Located adjacent to the University of Technology Sydney, education and training is the largest employment industry in the area, followed almost equally by professional, scientific and technical services and information media and telecommunications.

Geographically, South Ultimo is located to the southeast of Pyrmont, which is in itself a small cluster of commercial buildings. Several media, technology and creative occupiers seek accommodation with limited supply, exerting upward pressure on commercial rents.

For commercial uses, the precinct has a media and creative industry focus, incorporating companies such as Global Switch. Strong tenant demand in the area coupled with a limited supply is evident from the currently in-progress refurbishment of 100 Harris Street. Competition is already fierce for space in this development.

Given the area's location adjacent to a major institutional asset, it is in an excellent position to accommodate floor space demand for education-related uses. Like many other businesses, education and training providers and information media and telecommunications businesses have a tendency to cluster with similar businesses. This also helps build critical mass to offer retail and amenities.

As with other precincts within Central Sydney, South Ultimo is subject to strong pressure for residential development.

